



SINOtec®

PRODUCT RANGE 2018

TransTac® Welding protection

CURTAINS, STRIP CURTAINS, ROBOTIC PROTECTION SCREENS



TransTac

The TransTac product line offers an extensive range of welding protective curtains & strips as well as the appropriate accessories. The standard curtains can be slid to the side just like a normal curtain and the thicker strip curtains offer access to any place.

TransLux welding and robotic protective screens provide important protection against welding arc radiations. The material is available as a sheet or it can be fitted into an aluminum frame directly.

SINOtec also offers a complete range of heat protection products, e.g. heat protection pillows, curtains or blankets. You can find our welding protection screens in a different catalogue. Further information about TransTac B1 – hardly inflammable can also be found in a separate catalogue.



Content

General Welding Protection	4
The TransTac System	5
TransTac Welding and Protective Curtains	
■ Standard curtains 1300 mm	6
■ Standard curtains 2000 mm	7
■ Custom-made curtains and Curtain Accessories	8
■ Welding and Protective Curtains Plus	9
Welding Strip Curtains	
■ Strip Curtains 470 x 0,4 mm	10
■ Strip Curtains 570 x 1,0 mm	11
Strips and Films	
■ Material rolls for welding protection	12
■ Material rolls for strips / Special strips	13

Trans Tac[®]

Welding Protection

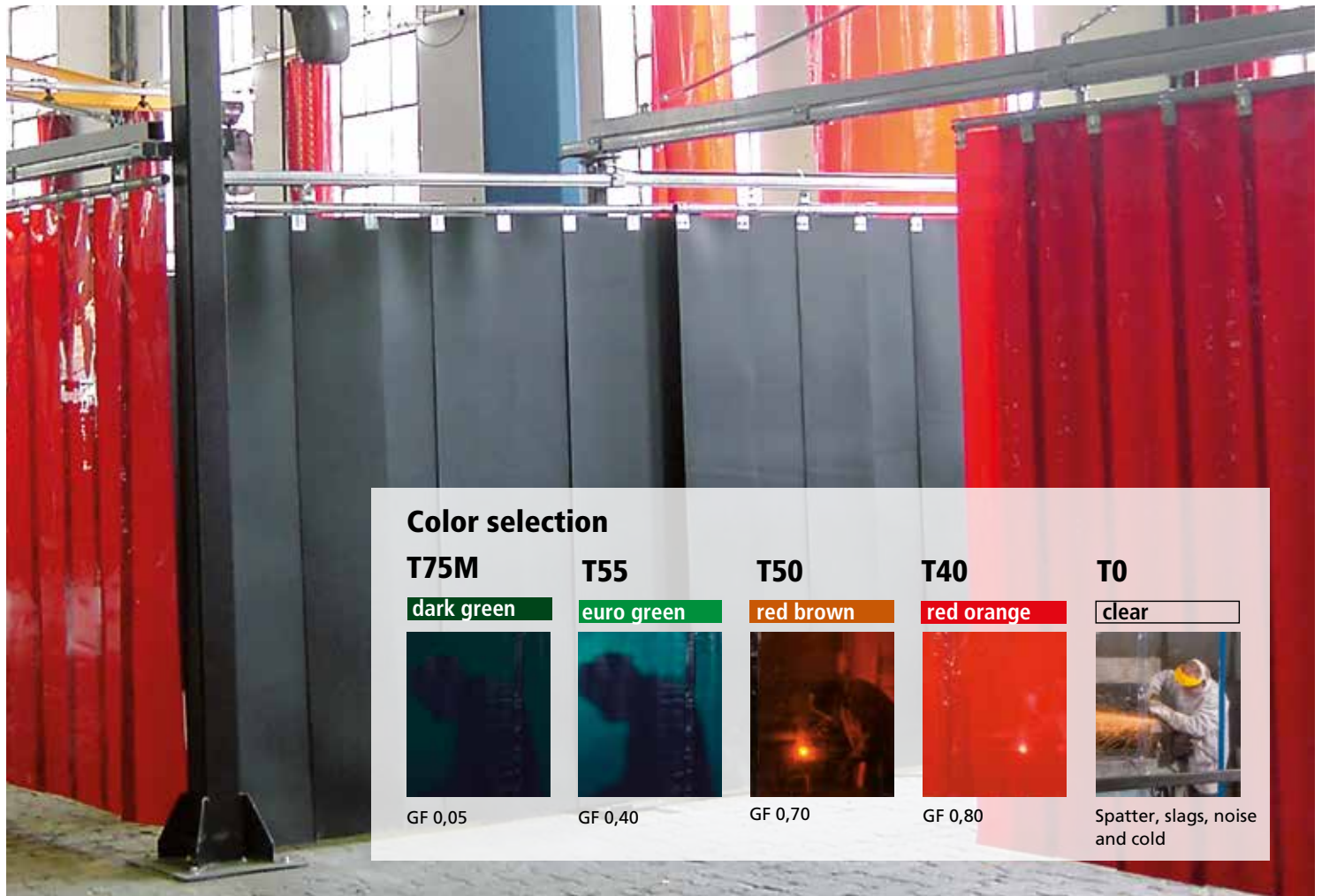

Color selection

T75M

dark green



GF 0,05

T55

euro green



GF 0,40

T50

red brown



GF 0,70

T40

red orange



GF 0,80

T0

clear



Spatter, slags, noise and cold

Strip curtains

- Welding strip curtains (cuttings) 14
- Clear strip curtains (cuttings) 15

Strip Fixing System

- Strip fixing system fixed/ lateral sliding 16
- Steel hanger fixing system 17

TransLux

- TransLux welding and robotic screens 18-20
- Clear TransLux screens 21

Heat protection

- Heat protection (material rolls) 22
- Heat protection blanket 23
- Heat protection curtains, cuttings/accessories 24
- Heat protection pillows 25

DämmTac Film

- DämmTac material rolls 26
- DämmTac cuttings 27

Accessories

- Curtain accessories 28-29
- Strip curtain accessories 30-31
- Ceiling suspensions 32
- Universal accessories 33
- Universal accessories 34
- Retracting cable reel 35
- Swivel arms/ Stands 36-38
- Swivel arms 39
- Telescopic rails 40-41

TransMatic

- TransMatic Powered Curtains 42
- TransMatic Sliding Rail 42

- Planning a Project 43

The TransTac System

TransTac assembly guide for welding protection curtains and strip curtains

Curtain System

TransTac curtains offer a DIN certified welding protection at favorable terms and very short delivery time. They have reinforced eyelets along the top. The curtains are hung up to the C-rail by PA-hooks. This solution ensures a simple sliding to parking position like a normal curtain. In case of larger heights there are special runners. K-hooks are used for fixing the curtains to a pipe or to safety screens.

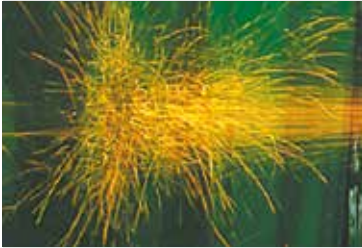

Spark-resistant flame retardation for a long service life. Depending on duration and intensity of use the right thickness can be chosen in the TransTac product range.



Tear-resistant hem to ensure tight fitting of several curtains.



End wall fixture



Ceiling fixture

Welding protection according to DIN EN ISO 25980:2015-01

All arc welding processes radiate hazardous UV- and IR-rays. During arc welding the arc emits a radiation which is similar to the sun. The irradiance is 500 times stronger than it should naturally be. The blending distracts the welder and may lose concentration.

The technical rules of the radiation regulations were concretized as a result of the EU-Directive. The parts that are used as a protection against incoherent radiation, which belong to the category welding radiation, were published in October 2013. Therefore the employer is obligated to create a risk assessment for each workplace where artificial and optical radiation can interfere.

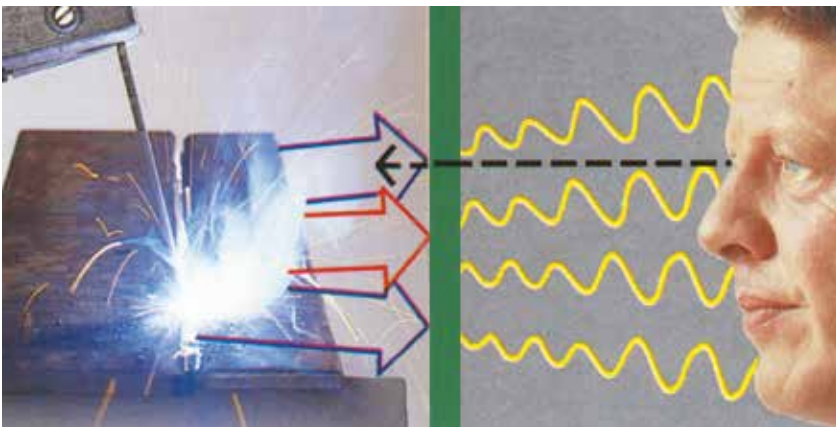

If the technical rules meet the requirements, then the radiation regulations are fulfilled. Simultaneously, the conditions of the accident prevention regulations of the German "Berufsgenossenschaft" are also met.

The welding radiations are not dangerous as long as the working environment is encased by TransTac welding protective curtains or strips which are according to DIN EN ISO 25980. Slags and welding spatter as well as dirt or moisture are held back by the partition.

The welding curtains in the models **T75M / T55 / T50 / T40** are for all arc welding processes, which are certified according to DIN EN 1598:2011 and DIN EN ISO 25980:2015-01. The models T75M (dark green matte) and T40 (red orange) are also available in B1 hardly inflammable.

Strip Curtain System

TransTac strip curtains are very rugged. As they are made of single strips, the material or workpieces are transported into or out the cabins without any problems. Also persons can pass through when the construction height allows it. The strips are mounted with swing clamps to the pipe so that they swing backwards and forwards resulting in less stress on the mounting points. In case of high openings the strips are fixed with plastic rocket shells. Depending on the use it makes sense to use sliding segments. These doors accelerate the production flow and facilitate free passage.



Fast and simple assembly of strip curtains. Strips are supplied with mounting holes punched. Swing clamps prevent the bending stress.



Simple design system. Only few elements are required to realize any shape of cabinet. All the different TransTac modular systems can be combined.



Sliding doors accelerate the production flow and facilitate free passage.

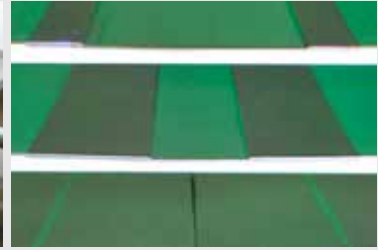

Different overlaps 33% = 50 mm for light draught and short lengths
66% = 100 mm for medium draught and greater heights
100% = 150 mm for strong draught and as noise protection

According to DIN EN 1598:2011-12 and DIN EN ISO 25980:2015, curtains and screens have to filter hazardous UV and IR-rays.

Spectral transmission factor between 210 - 313 nm	max. 0,002 %
Spectral transmission factor between 313 - 400 nm	< 3 %
Light transmission factor	> 0,0001 %
Hazard level in the wavelength from 400 up to 1400 nm	G < 1

Transmittance:

The luminous transmittance shall be greater than 0,0001 %. Additional specifications are also required.

Reflection:

The spectral reflectance shall be less than 10%.

UV-Stability:

The relative change of the luminous transmittance shall not be greater than +/- 20%.

Resistance to ignition:

According to DIN EN 1598:2011-12 and DIN EN ISO 25980:2015-01 the flame height does not reach the specified mark.



Dust and grinding protection

TransTac clear protective curtains T0 offer best visibility. They are conditionally spark-resistant and flame-retardant and are used as protection against splashes, grinding, dust, noise, cold and also to save energy. It is also available in the model B1 hardly inflammable.

Welding and Protective Curtains



Welding curtain T55 (euro green)

Standard Curtains 1.300 mm wide – with folded edges

Product advantages:

- stable
- delivery ex stock
- durable

Also available in the model **B1** hardly inflammable. Please check our separate catalogue.

Protective curtains, with 7 reinforced eyelets along the top, with snap fasteners down each side to join more than one curtain together. Thickness: 0.4 mm. Delivery ex stock.

Curtain model:	T75 matte**	T55	T50	T40**	T0**	
Certificates:	dark green	euro green	red brown	red orange	clear	
DIN EN 1598:2011-12						
DIN EN ISO 25980:2015-01						
Risk factor:	approx. 0,05	approx. 0,40	approx. 0,70	approx. 0,80		
Size	Weight	Article no.	Article no.	Article no.	Article no.	
1.600 mm	1,30 kg/pc.	TTV-T75M-130x160	TTV-T55-130x160	TTV-T50-130x160	TTV-T40-130x160	TTV-T0-130x160
1.800 mm	1,45 kg/pc.	TTV-T75M-130x180	TTV-T55-130x180	TTV-T50-130x180	TTVT40-130x180	TTV-T0-130x180
2.000 mm	1,60 kg/pc.	TTV-T75M-130x200	TTV-T55-130x200	TTV-T50-130x200	TTV-T40-130x200	TTV-T0-130x200
2.200 mm	1,75 kg/pc.	TTV-T75M-130x220	TTV-T55-130x220	TTV-T50-130x220	TTV-T40-130x220	TTV-T0-130x220
2.400 mm	1,90 kg/pc.	TTV-T75M-130x240	TTV-T55-130x240	TTV-T50-130x240	TTV-T40-130x240	TTV-T0-130x240
3.000 mm	2,30 kg/pc.	TTV-T75M-130x300	TTV-T55-130x300	TTV-T50-130x300	TTV-T40-130x300	TTV-T0-130x300
Special length*	0,60 kg/m ²	TTV-T75M-SL	TTV-T55-SL	TTV-T50-SL	TTV-T40-SL	TTV-T0-SL

Protection curtain against spatters, noise and cold. Resistant to sparks and flame-resistant. Resistant to flammability according to K1/0, 36mm (approx. DIN 4102 B2)

Delivery ex stock Delivery approx. 2 weeks

*Minimum price for special length curtains is 35,- €pc.

**In T75M (dark green matte) and T40 (red orange)

Standard curtains 1.400 mm wide - without folded edges on demand.

Welding and Protective Curtains

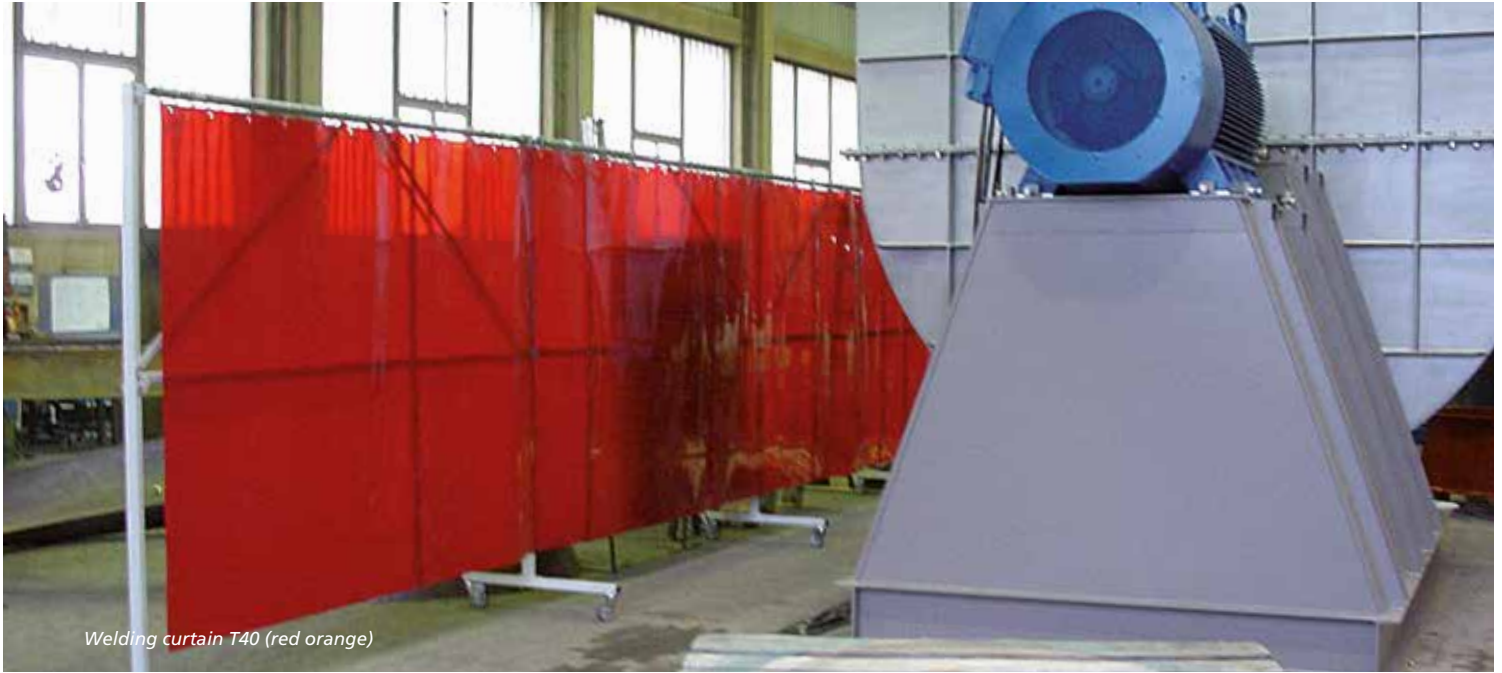



Welding curtain T40 (red orange)

Standard Curtains 2.000 mm wide – **without folded edges**

Product advantages:

- greater covering area
- therefore more inexpensive

Protective curtains, with 10 reinforced eyelets along the top, with snap fasteners down each side to join more than one curtain together. Thickness: 0.4 mm. Delivery generally ex stock or made to order depending on specific requirements.

Curtain model:		T75M	T55	T40	
Certificates:		dark green matte	euro green	red orange	
DIN EN 1598:2011-12					
DIN EN ISO 25980:2015-01					
Risk factor:		approx. 0,05	approx. 0,40	approx. 0,80	
Size	Weight	Article no.	Article no.	Article no.	
1.600 mm	2,00 kg/pc.	TTM-T75M-200x160	TTM-T55-200x160	TTM-T40-200x160	
1.800 mm	2,20 kg/pc.	TTM-T75M-200x180	TTM-T55-200x180	TTM-T40-200x180	
2.000 mm	2,50 kg/pc.	TTM-T75M-200x200	TTM-T55-200x200	TTM-T40-200x200	
2.200 mm	2,70 kg/pc.	TTM-T75M-200x220	TTM-T55-200x220	TTM-T40-200x220	
2.400 mm	2,90 kg/pc.	TTM-T75M-200x240	TTM-T55-200x240	TTM-T40-200x240	
3.000 mm	3,20 kg/pc.	TTM-T75M-200x300	TTM-T55-200x300	TTM-T40-200x300	
Special length*	0,60 kg/m²	TTM-T75M-200xSL	TTM-T55-200xSL	TTM-T40-200xSL	

Delivery ex stock Delivery approx. 2 weeks

*Minimum price for special length curtains is 50,-€/pc.

Welding and Protective Curtains

Custom-made curtains With or without folded edges

We can supply special-sized curtains according to request:

- Production according to your requirements or drawing
- We will be happy to advise you on your personal requirements and submit customized solutions for you
- Maximum size of the curtain is approx. 5 x 5 m
- Special designs such as mixed curtains on demand
- A variety of individual options are possible such as velcro, additional reinforcement or lead tape

Also available in the model **B1** hardly inflammable.
Please check our separate catalogue.



Protective curtains, with reinforced eyelets (distance approx. 200 mm) along the top, with snap fasteners down each side to join more than one curtain together. Thickness: 0,4 mm. Curtains are made to order.

Curtain model:	T75 matte**	T55	T50	T40**	T0**	
Certificates	dark green	euro green	red brown	red orange	clear	
DIN EN 1598:2011-12						
DIN EN ISO 25980:2015-01						
Risk factor:	approx. 0,05	approx. 0,40	approx. 0,70	approx. 0,80		
Size	Weight	Article no.	Article no.	Article no.	Article no.	
with folded edges	0,60 kg/m ²	TTV-T75M-SG	TTV-T55-SG	TTV-T50-SG	TTV-T40-SG	TTV-T0-SG
without folded edges	0,60 kg/m ²	TTM-T75M-SG	TTM-T55-SG	TTM-T50-SG	TTM-T40-SG	TTM-T0-SG

Protection curtain against spatters, noise and cold.
Resistant to sparks and flame-resistant. Resistant to flammability according to K1/0, 36mm (approx. DIN 4102 B2)

Delivery time approx. 2 weeks (after clarification of all technical details)

*Minimum price for special length curtains is 50€/pc.

**Also available in T75M (dark green matte) and T40 (red orange)
B1 hardly inflammable

Standard Accessories

Article	Description	Suited for	Article no.
Velcro fleece	width 25mm, black, sewed concealed	Curtains 0,4 mm	TTV-Z-KLETTB-VERN
Velcro	width 25mm, black, self-adhesive, delivery separately	Curtains 0,4 mm	OCO-Z-KLETTB-H
Lead tape	200 g/m, welded in the folded edges	Curtains 0,4 mm	TTV-Z-BLEISCHNUR
Eyelet	additional eyelet, dia. 12mm, plastic, welded	Curtains 0,4 – 2,0 mm	TTV-Z-OESE-GESCHW
Snap fastener	additional snap fastener, plastic, welded	Curtains 0,4 – 2,0 mm	TTV-Z-DRUCKK-VERS
Additional welding seam	up to 1,3 m length	Curtains 0,4 mm	TTV-Z-SCHWEISSNAHT

Delivery approx. 2 weeks

Further accessories can be found on page 28-29

Welding and Protective Curtains **plus**

TransTac Plus Curtains without folded edges

TransTac Plus curtains are used for exceptional performance especially

- for grinding
- when strength and durability of the PVC is required
- when conventional curtains are easily damaged
- when the coverage of strips are not sufficient
- for closed cabins
- for isolation

Also available in the model **B1** hardly inflammable. Please check our separate catalogue.



TransTac Plus curtains in T40 (red orange)



TransTac Plus Curtains, thickness 2 mm, width 1.500 mm without folded edges

Protective curtains for exceptional performance: With 8 reinforced eyelets (approx. 200 mm distance apart) along the top, with snap fasteners down each side to join more than one curtain together, 2.0 mm thick. Curtains are made to order.

Sizes and dimensions:

Standard width: 1500 mm
 Special width: Standard width < 1500 mm on demand
 Maximum height: approx. 5 m
 Thickness: 2,0 mm

TransTac Plus curtains T75 are only available with a smooth surface.

Curtain model:	T75	T55	T50	T40**	T0**
Certificates DIN EN 1598:2011-12 DIN EN ISO 25980:2015-01	dark green	euro green	red brown	red orange	clear
Risk factor:	 approx. 0,05	 approx. 0,40	 approx. 0,70	 approx. 0,80	 Protection curtain against spatters, noise and cold. Resistant to sparks and flame-resistant. Resistant to flammability according to K1/0, 36mm (approx. DIN 4102 B2)

Size	Weight	Article no.	Article no.	Article no.	Article no.	Article no.
1.600 mm	6,0 kg/pc.	TTP-T75-2MM-160	TTP-T55-2MM-160	TTP-T50-2MM-160	TTP-T40-2MM-160	TTP-T0-2MM-160
1.800 mm	6,75 kg/pc.	TTP-T75-2MM-180	TTP-T55-2MM-180	TTP-T50-2MM-180	TTP-T40-2MM-180	TTP-T0-2MM-180
2.000 mm	7,2 kg/pc.	TTP-T75-2MM-200	TTP-T55-2MM-200	TTP-T50-2MM-200	TTP-T40-2MM-200	TTP-T0-2MM-200
Special length*	2,5 kg/m ²	TTP-T75-2MM-SL	TTP-T55-2MM-SL	TTP-T50-2MM-SL	TTP-T40-2MM-SL	TTP-T0-2MM-SL
Special size*	2,5 kg/m ²	TTP-T75-2MM-SG	TTP-T55-2MM-SG	TTP-T50-2MM-SG	TTP-T40-2MM-SG	TTP-T0-2MM-SG

 Delivery time approx. 2 weeks  Delivery time on request

*Minimum price for special length curtains is 50 €/pc.
 **Also available in T40 (red orange) and T0 (clear) B1 hardly inflammable

Welding and Protective Strip Curtains

Welding protection- Strip curtains without folded edges

Product advantages

- 4 reinforced eyelets along the top
- Simple lateral sliding with PA hooks, K hooks or runners
- Easy and quickly exchanged
- Stable
- Durable
- Inexpensive







Strip Curtains 470 x 0,4 mm

- Strips with 4 reinforced eyelets
- Strips with an overlap of 70 mm
- 5 strips = 2070 mm width
- Thickness: approx. 0,4 mm
- Delivery approx. 2 weeks
- Cover width = 400 mm

Sizes and dimensions:

Thickness:	0,4 mm
Width:	470 mm
Overlap:	50 mm
Cover width:	470 mm

Standard strip curtains, Thickness 0,4 mm, Width 470 mm – without folded edges

Curtain model:	T75 matte	T50	T40	T0	
Certificates DIN EN 1598:2011-12 DIN EN ISO 25980:2015-01	dark green 	red brown 	red orange 	clear 	
Risk factor:	approx. 0,05	approx. 0,70	approx. 0,80	Protection curtain against spatters, noise and cold. Resistant to sparks and flame-resistant. Resistant to flammability according to K1/0, 36mm (approx. DIN 4102 B2)	
Size	Weight	Article no.	Article no.	Article no.	
1.600 mm	0,37 kg/pc.	TTL-T75M-04-1600	TTL-T50-04-1600	TTL-T40-04-1600	TTL-T0-04-1600
1.800 mm	0,42 kg/pc.	TTL-T75M-04-1800	TTL-T50-04-1800	TTL-T40-04-1800	TTL-T0-04-1800
2.000 mm	0,47 kg/pc.	TTL-T75M-04-2000	TTL-T50-04-2000	TTL-T40-04-2000	TTL-T0-04-2000
2.200 mm	0,51 kg/pc.	TTL-T75M-04-2200	TTL-T50-04-2200	TTL-T40-04-2200	TTL-T0-04-2200
2.400 mm	0,56 kg/pc.	TTL-T75M-04-2400	TTL-T50-04-2400	TTL-T40-04-2400	TTL-T0-04-2400
Special length	0,23 kg/m ²	TTL-T75M-04-SL	TTL-T50-04-SL	TTL-T40-04-SL	TTL-T0-04-SL

 Delivery ex stock

 Delivery time approx. 2 weeks

Strip Curtains







Standard Strip Curtains *without folded edges*

- 4 reinforced eyelets along the top
- Easily and quickly exchanged
- Simple lateral sliding with PA hooks, K hooks or plastic runners
- Special widths and models on demand, minimum quantity 500 m²

Sizes and dimensions:

Thickness:	1,0 mm
Width:	570 mm
Overlap:	70 mm
Cover width:	500 mm

Standard strip curtains, Thickness 1,0 mm, Width 570 mm – *without folded edges*

Curtain model:	T75 matte	T55	T50	T40	T0
Certificates	dark green	euro green	red brown	red orange	clear
DIN EN 1598:2011-12					
DIN EN ISO 25980:2015-01					
Risk factor:	approx. 0,05	approx. 0,40	approx. 0,70	approx. 0,80	Protection curtain against spatters, noise and cold. Resistant to sparks and flame-resistant. Resistant to flammability according to K1/0, 36mm (approx. DIN 4102 B2)

Size	Weight	Article no.	Article no.	Article no.	Article no.	Article no.		
1.600 mm	1,12 kg/pc.	TTL-T75M-1-1600	TTL-T55-1-1600	TTL-T50-1-1600	TTL-T40-1-1600	TTL-T0-1-1600		
1.800 mm	1,25 kg/pc.	TTL-T75M-1-1800	TTL-T55-1-1800	TTL-T50-1-1800	TTL-T40-1-1800	TTL-T0-1-1800		
2.000 mm	1,40 kg/pc.	TTL-T75M-1-2000	TTL-T55-1-2000	TTL-T50-1-2000	TTL-T40-1-2000	TTL-T0-1-2000		
2.200 mm	1,55 kg/pc.	TTL-T75M-1-2200	TTL-T55-1-2200	TTL-T50-1-2200	TTL-T40-1-2200	TTL-T0-1-2200		
Special length*	0,75 kg/m	TTL-T75M-1-SL	TTL-T55-1-SL	TTL-T50-1-SL	TTL-T40-1-SL	TTL-T0-1-SL		

 Delivery ex stock

 Delivery time approx. 2 weeks

Delivery unit 4 pcs. in a plastic bag, corresponding to a width of 2070 mm, 1 package = 16 pcs.

Welding Curtain and Strip Material Rolls

Rolls for **Welding Strip Curtains**

Advantages of strips

- Quick delivery
- Adjustment of the strip curtains on the spot to suit application
- Individual lengths are achievable, especially for replacements

Also available in the model **B1** hardly inflammable. Please check our separate catalogue.

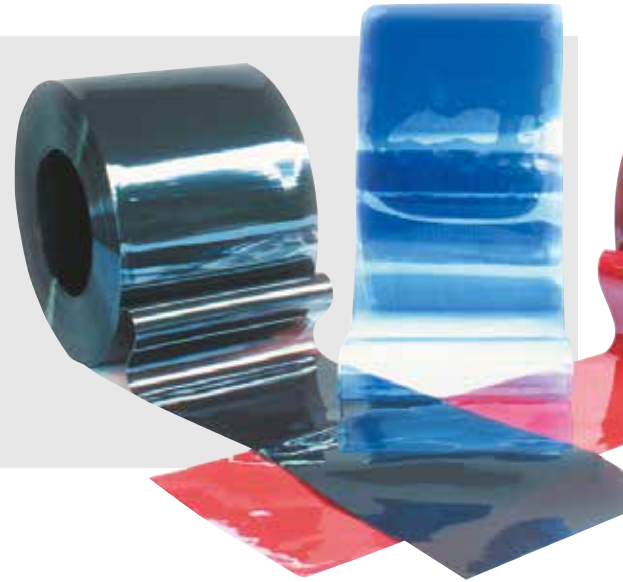

Information about TransTac material rolls

TransTac strips are indispensable in applications where material or workpieces are transported into or out of the welding cabins and ensure the safe movement of workpieces. Due to the overlap, the strips easily part which allows an easy access and they close by themselves again afterwards, thus preventing arcs or sparks from exiting the cabin. The material can easily be cut with a plate shear or sharp utility knife.

Curtain model:	T75 matte	T55	T50	T50 matte	T40
Certificates	dark green	euro green	red brown	red brown	red orange
DIN EN 1598:2011-12					
DIN EN ISO 25980:2015-01					
Risk factor:	approx. 0,05	approx. 0,40	approx. 0,70	approx. 0,70	approx. 0,80
Size	Weight	Article no.	Article no.	Article no.	Article no.

Welding Strip Material: Rolls of 50 m

300 x 2mm*	0,75 kg/m	TTL-T75M-2MM-R-3	TTL-T55-2MM-R-3	TTL-T50-2MM-R-3	TTL-T50M-2MM-R-3	TTL-T40-2MM-R-3
300 x 3mm*	1,10 kg/m	TTL-T75M-3MM-R-3	TTL-T55-3MM-R-3	TTL-T50-3MM-R-3	TTL-T50M-3MM-R-3	TTL-T40-3MM-R-3
570 x 1mm*	0,70 kg/m	TTL-T75M-1MM-R-57	TTL-T55-1MM-R-57	TTL-T50-1MM-R-57		TTL-T40-1MM-R-57

Welding Curtain Material: Rolls of 20/50 m

1400x0,4mm*	0,50 kg/m ²	TTV-T75M-R-140	TTV-T55-R-140	TTV-T50-R-140		TTV-T40-R-140
2000x0,4mm*	0,50 kg/m ²	TTV-T75M-R-200	TTV-T55-R-200			TTV-T40-R-200
1500x2mm**	2,50 kg/m ²	TTV-T75-2MM-R-150***	TTV-T55-2MM-R-150	TTV-T50-2MM-R-150		TTV-T40-2MM-R-150

* = Rolls of 50 m ** =Rolls of 20 m *** = Quality T75 is only available in a smooth surface

= certified by = certified by

Cutting from a roll	TTL-D-Roll
Cutting of strips with standard punching 4 x 6	TTL-D-LAM-STAND
Cutting of strips with special punching	TTL-D-LAM-SONDER

Delivery ex stock Delivery approx. 2 weeks Delivery on request

Welding and Strip Material Rolls



Standard Strips

Clear T0 strip material rolls

Clear curtain or strip material (not suitable for arc welding) protects against grinding, moisture, dust, cold and draught. The standard quality is suitable for a temperature range of -20 °C to + 50 °C used for standard requirements.

Also available in the model **B1** – hardly inflammable. Please check our separate catalogue.

Strip Material, Standard Quality: Rolls of 50 m

Size	Weight	Article no.	Price €	Size	Weight	Article no.	Price €
200 x 2 mm	0,50 kg/m	TTL-T0-2MM-R-2		300 x 5 mm	1,85 kg/m	TTL-T0-5MM-R-3	
300 x 2 mm	0,75 kg/m	TTL-T0-2MM-R-3		400 x 4 mm	1,95 kg/m	TTL-T0-4MM-R-4	
300 x 3 mm	1,10 kg/m	TTL-T0-3MM-R-3		1400 x 0,4 mm	0,50 kg/m ²	TTV-T0-R-140	
570 x 1 mm	0,7 kg/m	TTL-T0-1MM-R-57					

Please look on page 14-15 for cuttings

Colored transparent strips – material rolls

Different sizes are also available in the following colors:

- red transparent strips
- yellow transparent strips
- further colors of colored transparent strips on demand

***Special strip material:** Red transparent or yellow transparent strips used as boundary strips (surcharge +10%). Special sizes on demand. Delivery time: approx. 2 weeks

Clear T0 cold-resistant strips – material rolls

These cold-resistant strips are used where temperatures between -50°C and +15°C are encountered. This material is especially used in areas where the temperature is below -20°C. Field of application: Cold-storage depot, separation of cold passageways in the food processing industry.

Clear T0 cold-resistant strips – rolls of 50

200 x 2 mm*	0,50 kg/m	TTL-T0-2MM-R-2-K		300 x 3 mm*	1,10 kg/m	TTL-T0-3MM-R-3-K	
-------------	-----------	------------------	--	-------------	-----------	------------------	--

Clear T0 antistatic strips – material rolls

These antistatic strips are mainly used where an increased requirement to dust protection is necessary for example in dust-free rooms. Due to the addition of additives the film resistivity is decreased to approx. 2,03 x 10¹² Ohm. Therefore this material can be used in rooms with electrostatic risks provided that all elements are connected numerously with the ground. In the course of time this product loses its antistatic effects by the diffusion of its flexibilizer and its antistatic additives. We urgently recommend a regular examination of the resistivity when the PVC films are used in sensitive areas.

Clear T0 antistatic strips – rolls of 50

200 x 2 mm*	0,50 kg/m	TTL-T0-2MM-R-2-A		300 x 3 mm*	1,10 kg/m	TTL-T0-3MM-R-3-A	
-------------	-----------	------------------	--	-------------	-----------	------------------	--

Delivery ex stock

Delivery time approx. 2 weeks

* = Only supplied as a roll of 50 m

Strip Curtains

Welding Strip Curtains (Cuttings)

Strips cut to length, holes punched according to overlap. Curtains are manufactured to customer's specification.

The curtains offer the protection of the neighborhood of welding workplaces used as partitions or cabins. **Thickness:** 2.0 mm or 3.0 mm

Strips T75M / T55 / T50 / T50M / T40 suited for all arc welding processes, certified according to DIN EN 1598:2011-12 and DIN EN ISO 25980:2015-01.

Strip cut to length with punched holes

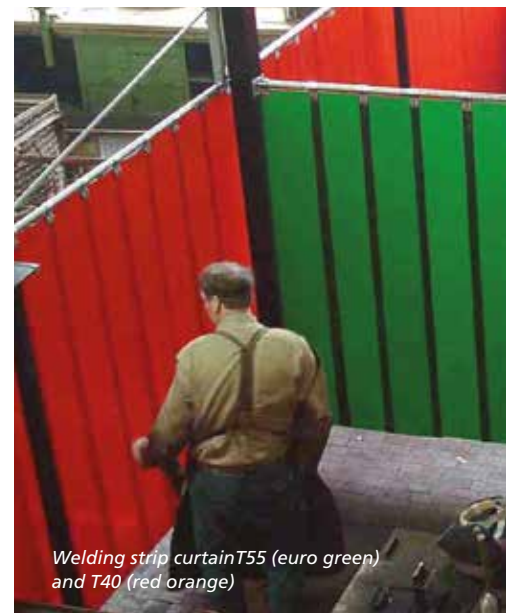
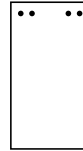

Welding strip curtain T55 (euro green) and T40 (red orange)

Also available in the model **B1** hardly inflammable. Please check our separate catalogue.

Strip width 300 mm
Overlap 33% = 2 x 50 mm



Strip width 400 mm
Overlap 66% = 2 x 100 mm



Curtain model:	T75 matte	T55	T50	T50 matte	T40
Certificates:	dark green	euro green	red brown	red brown	red orange
DIN EN 1598:2011-12					
DIN EN ISO 25980:2015-01					
Risk factor:	approx. 0,05	approx. 0,40	approx. 0,70	approx. 0,70	approx. 0,80
Size	Weight	Article no.	Article no.	Article no.	Article no.

Strips with Hole Punching for TransTac Swing Clamps 6 mm

300x2mm/33%	3,0 kg/m ²	TTL-T75M-2MM-33	TTL-T55-2MM-33	TTL-T50-2MM-33	TTL-T50M-2MM-33	TTL-T40-2MM-33
300x2mm/66%	3,8 kg/m ²	TTL-T75M-2MM-66	TTL-T55-2MM-66	TTL-T50-2MM-66	TTL-T50M-2MM-66	TTL-T40-2MM-66
300x3mm/33%	4,5 kg/m ²	TTL-T75M-3MM-33	TTL-T55-3MM-33	TTL-T50-3MM-33	TTL-T50M-3MM-33	TTL-T40-3MM-33
300x3mm/66%	5,7 kg/m ²	TTL-T75M-3MM-66	TTL-T55-3MM-66	TTL-T50-3MM-66	TTL-T50M-3MM-66	TTL-T40-3MM-66
300x3mm/100%	7,2 kg/m ²	TTL-T75M-3MM-100	TTL-T55-3MM-100	TTL-T50-3MM-100	TTL-T50M-3MM-100	TTL-T40-3MM-100

Strips with Hole Punching for TransTac Rocket Shells 8 mm

300x2mm/33%	3,0 kg/m ²	TTL-T75M-2MM-33-P	TTL-T55-2MM-33-P	TTL-T50-2MM-33-P	TTL-T50M-2MM-33-P	TTL-T40-2MM-33-P
300x2mm/66%	3,8 kg/m ²	TTL-T75M-2MM-66-P	TTL-T55-2MM-66-P	TTL-T50-2MM-66-P	TTL-T50M-2MM-66-P	TTL-T40-2MM-66-P
300x3mm/33%	4,5 kg/m ²	TTL-T75M-3MM-33-P	TTL-T55-3MM-33-P	TTL-T50-3MM-33-P	TTL-T50M-3MM-33-P	TTL-T40-3MM-33-P
300x3mm/66%	5,7 kg/m ²	TTL-T75M-3MM-66-P	TTL-T55-3MM-66-P	TTL-T50-3MM-66-P	TTL-T50M-3MM-66-P	TTL-T40-3MM-66-P
300x3mm/100%	7,2 kg/m ²	TTL-T75M-3MM-100-P	TTL-T55-3MM-100-P	TTL-T50-3MM-100-P	TTL-T50M-3MM-100-P	TTL-T40-3MM-100-P

Delivery approx. 1 week

Strips with special punching please look at page 12

Strip Curtains

Clear T0 Strip Curtains (Cuttings)

Clear Protective Curtains T0 (not suitable for arc welding)

The strips are mounted so that they swing forwards and backwards which results in less stress on the mounting points. This is why we recommend mounting the strips to the pipes with our tested TransTac 'swing clamps'.

When a fork lift passes through the strip curtains it creates tractive forces which cannot be diffused by the standard swing clamps. Therefore we suggest using heavy duty swing clamps or rocket shells. Please let us advice you.

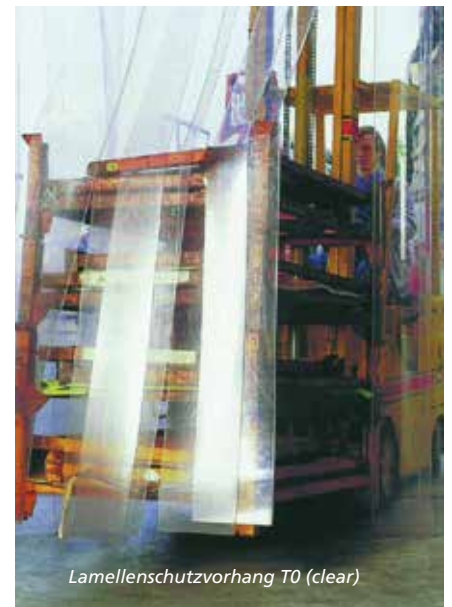

Lamellenschutzvorhang T0 (clear)

Strip width 300 mm
Overlap 100% = 2 x 150 mm



Strip width 400 mm
Overlap 50% = 2 x 100 mm



Also available in the model **B1** hardly inflammable. Please check our separate catalogue.

Clear T0 standard strip curtains

Size	Weight	Article no.	Size	Weight	Article no.
Strips T0 with Hole Punching for TransTac Swing Clamps 6 mm					
300x2mm/33%	3,0 kg/m ²	TTL-T0-2MM-33	300x3mm/66%	5,7 kg/m ²	TTL-T0-3MM-66
300x2mm/66%	3,8 kg/m ²	TTL-T0-2MM-66	300x3mm/100%	7,2 kg/m ²	TTL-T0-3MM-100
300x3mm/33%	4,5 kg/m ²	TTL-T0-3MM-33			
Strips T0 with Hole Punching for TransTac Rocket Shells 8 mm					
300x2mm/33%	3,0 kg/m ²	TTL-T0-2MM-33-P	300x3mm/100%	7,2 kg/m ²	TTL-T0-3MM-100-P
300x2mm/66%	3,8 kg/m ²	TTL-T0-2MM-66-P	300x5mm/66%	9,5 kg/m ²	TTL-T0-5MM-66-P
300x3mm/33%	4,5 kg/m ²	TTL-T0-3MM-33-P	300x5mm/100%	11,5 kg/m ²	TTL-T0-5MM-100-P
300x3mm/66%	5,7 kg/m ²	TTL-T0-3MM-66-P	400x4mm/50%	6,2 kg/m ²	TTL-T0-4MM-50-P

Delivery approx. 1 week

Strips with special punching please look at page 12

Clear T0 strip curtains with special qualities

SINOftec supplies the following strip curtains for exceptional performance:

- Colored transparent strip curtains (red transparent, yellow transparent) used as boundary strips
- Clear T0 strip curtains with increased flame-resistance attributes
- Clear T0 cold-resistant strip curtains where temperatures down to -45°C are encountered
- Clear T0 antistatic strip curtains

Strip fixing system



Strip fixing system, fixed

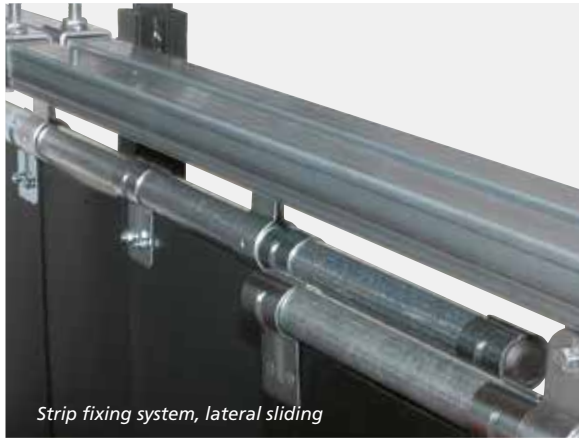

Strip fixing system, lateral sliding



Strip fixing systems are made to the customer's specification
Delivery approx. 1 week

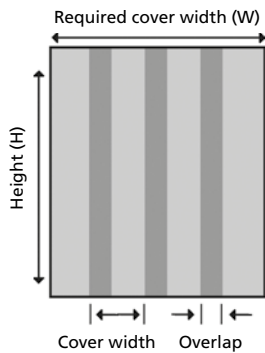

* = Cover width 250 mm
** = Cover width 200 mm
*** = Cover width 150 mm

Overlap	Required Cover Width (W) in mm														
	1	2	3	4	5	6	7	8	9	10	11	12	13	14	15
33% (=50 mm)*	300	550	800	1050	1300	1550	1800	2050	2300	2550	2800	3050	3300	3550	3800
66% (=100 mm)**	300	500	700	900	1100	1300	1500	1700	1900	2100	2300	2500	2700	2900	3100
100% (=150 mm)***	300	450	600	750	900	1050	1200	1350	1500	1650	1800	1950	2100	2250	2400

Overlap	Required Cover Width (W) in mm														
	16	17	18	19	20	21	22	23	24	25	26	27	28	29	30
33% (=50 mm)*	4050	4300	4550	4800	5050	5300	5550	5800	6050	6300	6550	6800	7050	7300	7550
66% (=100 mm)**	3300	3500	3700	3900	4100	4300	4500	4700	4900	5100	5300	5500	5700	5900	6100
100% (=150 mm)***	2550	2700	2850	3000	3150	3300	3450	3600	3750	3900	4050	4200	4350	4500	4650

Strip Fixing System, fixed (standard)

Article	Description	Overlap	Weight	Article no.	
	Consisting of pipe, swing clamps or rocket shells, wall or ceiling fixtures, complete	swing clamp	33%	4,0 kg/m	TTL-AUFH-F-33
		rocket shell	33%	5,0 kg/m	TTL-AUFH-F-33-P
	swing clamp	66%	4,5 kg/m	TTL-AUFH-F-66	
		rocket shell	66%	4,5 kg/m	TTL-AUFH-F-66-P
	swing clamp	100%	5,0 kg/m	TTL-AUFH-F-100	
		rocket shell	100%	5,0 kg/m	TTL-AUFH-F-100-P

Strip Fixing System, lateral sliding

Article	Description	Overlap	Weight	Article no.	
	consisting of C-rails, ball-bearing runners, pipe, swing clamps or rocket shells, wall or ceiling fixtures, buffers, complete	swing clamp	33%	9,0 kg/m	TTL-AUFH-B-33
		rocket shell	33%	9,0 kg/m	TTL-AUFH-B-33-P
	swing clamp	66%	9,5 kg/m	TTL-AUFH-B-66	
		rocket shell	66%	9,5 kg/m	TTL-AUFH-B-66-P
	swing clamp	100%	10,0 kg/m	TTL-AUFH-B-100	
		rocket shell	100%	10,0 kg/m	TTL-AUFH-B-100-P

Delivery approx. 1 week

Shipping with freight forwarding – additional charges for elongated items over 2,4 m

Steel hanger fixing system



Steel Hanger Fixing System – **Stainless Steel**

How to calculate the necessary material rolls

- Choose the strip width / overlap
- Determine the quantity with the help of the chart
- Multiple the desired quantity with the height (length)

The single strips are hooked into the steel hanger. The assembly and exchange of the strips is very quick and easy. Each strip is cut in the requested length and delivered with a riveted steel hanger plate. The steel hanger and steel hanger plates are made of stainless steel. The rivet is made of aluminum.

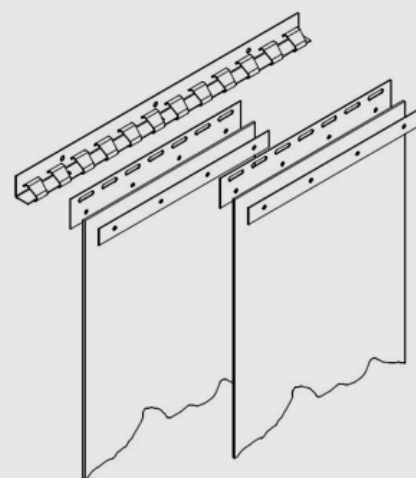

Strip width	Overlap	Width of Requested Strip Quantity approx. (m)										
		1	2	3	4	5	6	7	8	9	10	20
200 mm	37,5%	0,20	0,36	0,53	0,69	0,86	1,02	1,18	1,35	1,52	1,68	3,25
	63,5%	0,30	0,51	0,72	0,92	1,12	1,33	1,53	1,74	1,95	2,15	4,10
300 mm	37,5%	0,30	0,51	0,72	0,92	1,12	1,33	1,53	1,74	1,95	2,15	4,10
	57,5%	0,40	0,69	0,98	1,26	1,55	1,84	2,12	2,40	2,68	2,97	5,71
400 mm	37,5%	0,40	0,73	1,06	1,38	1,72	2,05	2,35	2,68	3,00	3,33	6,51
	57,5%	0,40	0,69	0,98	1,26	1,55	1,84	2,12	2,40	2,68	2,97	5,71

Article

Article no.

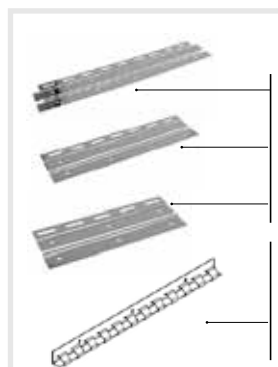

Cutting, punching and riveting

TTL-D-LAM-VERNIETEN

Steel hanger plate 200 width, 5 slots

TTL-Z-EINFASS-200

Steel hanger plate 300 width, 7 slots

TTL-Z-EINFASS-300

Steel hanger plate 400 width, 9 slots

TTL-Z-EINFASS-400

Steel hanger 48 hooks

TTL-Z-HAKENSCHIENE-1968

Steel hanger 36 hooks

TTL-Z-HAKENSCHIENE-1230

Steel hanger 24 hooks

TTL-Z-HAKENSCHIENE-984

Delivery approx. 2 weeks

Delivery ex stock

The prices for the strip curtain material rolls can be found on page 12 - 14

TransLux



The TransLux Rigid Screen Material

Polycarbonate is an extremely high impact resisting material; it also has a broad thermal application range and exceptional optical qualities. It is the ideal solution for viewing screens due to its impact resistance, high flexibility and visual transparency. An easy processing is ensured thanks to the cold and warm forming.

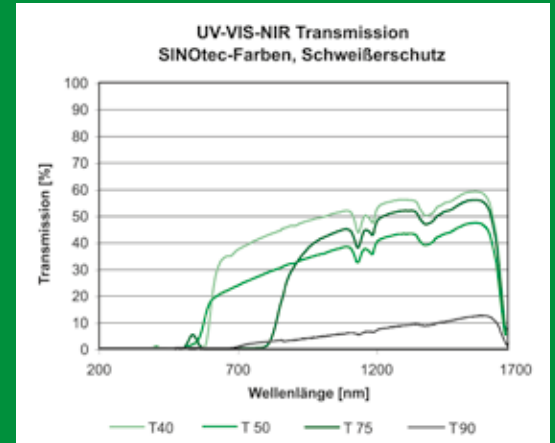

Aluminum frame construction

The plates are fitted into the aluminum frame. The price is approx. EUR 230/m² at a size of 10 m².

Steel or wooden frames are also possible by self-made construction.

Offer on demand.

It is not allowed to use TransLux as protective plate in welding helmets or shields!

TransLux



Application area

TransLux is used as a protection against artificial and optical radiation. This material is ideal to use as a monitor or visitor window for welding cabins with robots or manual welding. In this case of application the risk assessment of the UV exposure during normal welding is negligible. Even other UV radiations (e.g. during crack testing) are below the UV exposure limit behind the screens.

Type	Color	Risk factor	Product	Marking	Dark shade	Test report no.	Certification
T90	dark green	approx. 0,12	Screen for arc welding	ISO 25980 SINO	approx. 9	10191-ECS-15	DIN EN 1598: 2011-12 DIN EN ISO 25980: 2015-01
T75	dark green	approx. 0,60	Screen for arc welding	ISO 25980 SINO	approx. 7	10193-ECS-15	DIN EN ISO 25980: 2015-01
T75	dark green	Laser	Screen for laser beams	D A7+IR A3, 180-315 DIRM A5, >315-480 D A5+IR A6, 600-700 SINO	-	10752-ECS-08	DIN EN 12254 DIN EN ISO 25980: 2014
T55	green	approx. 0,90	Screen for arc welding	ISO 25980 SINO	approx. 5,5	10192-ECS-15	DIN EN ISO 25980: 2015-01
T50	bronze	approx. 0,98	Screen for arc welding	ISO 25980 SINO	approx. 4	10194-ECS-15	DIN EN ISO 25980: 2015-01
T40	red	approx. 0,56	Screen for arc welding	ISO 25980 SINO	approx. 4	10195-ECS-15	DIN EN ISO 25980: 2015-01
T40	red	Laser	Screen for arc welding	D A7+IR A3, 180-315 DIRM A5, >315-390 DIRM A5,450-535 SINO	-	10751-ECS-08	-
T40	red	Laser	Filter for laser beams	D L7+IR L3, 180-315 DIRM L5, >315-390 DIRML5 SINO S CE,450-535	-	10751-ECS-08	DIN EN 207: 2002
T0	clear	unsuitable for welding	Noise protection				

TransLux



The characteristics at a glance:

- Very high resistance to impact
- High robustness (elongation at tear > 80%)
- Can be formed and bent without heating
- Resistant against oil, petrol and grease
- Constant operable low temperature range down to -40 °C
- Non electrically conductive
- Constant operable high temperature range up to 115 °C
- Can be cut with fret-saw, disc-saw or plate shear etc.

TransLux Rigid Screen Material

Welding panel (sheet):

Certificates:

DIN EN 1598:2011-12
DIN EN ISO 25980:2015

Risk factor:

Corresponding to dark shade:

		T90	T75	T55	T50	T40
		dark green	dark green	euro green	red brown	red orange
		ISO 25980 SINO 10191-ECS15	ISO 25980 SINO 10193-ECS-15	ISO 25980 SINO 10192-ECS 15	ISO 25980 SINO 10194-ECS 15	ISO 25980 SINO 10195-ECS 15
		approx. 0,12	approx. 0,60	approx. 0,90	approx. 0,98	approx. 0,56
		approx. 9,00	approx. 7,00	approx. 4,00	approx. 4,00	approx. 4,00
Size	Weight	Article No.	Article No.	Article No.	Article No.	Article No.
2500x1250x3mm / 3,125m ² *	11,8 kg/sheet	TSS-T90-P	TSS-T75-P	TSS-T55-P	TSS-T50-P	TSS-T40-P
1250x1250x3mm / 1,56 m ²	5,90 kg/sheet	TSS-T90-P-2	TSS-T75-P-2	TSS-T55-P-2	TSS-T50-P-2	TSS-T40-P-2
1250x800x3mm / 1,00 m ²	3,75 kg/sheet	TSS-T90-P-3	TSS-T75-P-3	TSS-T55-P-3	TSS-T50-P-3	TSS-T40-P-3
1250x500x3mm / 0,625 m ²	2,4 kg/sheet	TSS-T90-P-5	TSS-T75-P-5	TSS-T55-P-5	TSS-T50-P-5	TSS-T40-P-5
Budgetary offer for cutting of sheets to customer's request	3,75 kg/m ²	TSS-T90	TSS-T75	TSS-T55	TSS-T50	TSS-T40

Complete sheets with special dimension

TSS-SG

Delivery ex work

Delivery approx. 2 weeks

The price for cuttings varies depending on size and quantity.
Minimum price per cutting is 50,00 €/pc.!

* = Shipping with one-way pallets 2500 x 1250 mm: 39,00 € additionally + additionally charges for elongated items

TransLux



Exceptional features

- 5/10 years guarantee* for weathering, transparency and resistance to fracturing*
- Increased robustness against continuous atmospheric conditions, extremely long life
- No yellowing or color changes, the panels will retain their clarity.

Area of application

- Protection of machines
- Protection of machines operators
- Partitions
- Noise protection
- Window panes

* = in case of appropriate treatment according our instructions

Standard Clear Panels

TransLux clear polycarbonate, UV stabilized

Size:

Thickness:

Complete sheet 3.050 x 2.050 mm	1 - 15 mm
Complete sheet 2.050 x 1.250 mm	1 - 15 mm
Cutting of sheets – price per m ²	1 - 15 mm

Delivery on pallet

Delivery approx. 2-3 weeks



Clear Panels for Exceptional Ranges of Application

TransLux, PC, antistatic – on demand

These panels consist of antistatic polycarbonate. They are especially used where highly sensitive components must be protected against electrostatic charging and pollution by dirt and dust particles. Typical areas of application are ESD protected machine covers, clean room lights as well as components in the microelectronics and test adapter works. The polycarbonate sheet has an antistatic coating which protects against electrostatic charge and prevents the attraction of dirt and dust. The main characteristics of the polycarbonate material such as high resistance to impact are completely preserved.

TransLux, PC, scratch resistant surface coating – on demand

Polycarbonate panels consist of a thin yet tough coating on one or both sides and are used in extreme applications against abrasion whilst also providing enhanced chemical resistance. They are also suitable for eye protection where there is an impact hazard by flying particles or against chemical splash hazards such as oil or solvents.

Heat Protection



Information about Heat Protection Articles

The heat protection articles of SINOtec are used where heat protection and fire protection is necessary to ensure health and safety at the workplace. SINOtec has different types of heat protection fabrics which match the different fields of application.

Field of application:

Cover of parts which are sensitive to heat, heat protection against grinding, spatter and welding beads, curtains can be used as partitions

SINOtec's heat protection range:

Material rolls, cuttings, ready-made heat blankets, ready-made heat curtains, mixed curtains – a combination with TransTac films on request, heat curtains or blankets made to the customer's specifications.

Heat Protection Fabrics - material rolls

Article	Temperature up to	Weight	Article no.
THR-600, glass fabric, aluminum coated, roll of 50 m, width 1000 mm	550 °C* / 600 °C**	0,72 kg/m ²	THV-BAL-600-R-100
THR-600, glass fabric, aluminum coated, roll of 50 m, width 2000 mm	550 °C* / 600 °C**	0,72 kg/m ²	THV-BAL-600-R-200
THR-1100, glass fabric, golden brown, roll of 50 m, width 920 mm	1000 °C* / 1100 °C**	1,1 kg/m ²	THV-GOL-1100-R-92
THR-900, glass fabric gray, roll of 50 m, width 1000 mm	750 °C* / 900 °C***	1,25 kg/m ²	THV-GRA-900-R-100
THR-900, glass fabric gray, roll of 50 m, width 2000 mm	750 °C* / 900 °C***	1,25 kg/m ²	THV-GRA-900-R-200
THR-800, carbon glass needle felt, roll of 50 m, width 1000 mm	550 °C* / 800 °C**	0,72 kg/m ²	THV-SCH-800-R-100

Delivery ex stock

* = permanent heat ** = peak temperature *** = at certain spots (welding beads)
Special heat protection fabrics and special widths are available on demand (min. quantity 2000 m²)

Heat Protection Blankets

THD-600 - Heat Protection Blankets made of glass fabrics, heat-resistant up to 550°C*/600°C**

THD-600 is a glass fabric coated on both sides with gray polyurethane filled with aluminum and shows good flame-resistant characteristics. Weight: approx. 720 g/m². Standard width: 1.000 mm. Color: gray silver. Tried and tested against welding splashes, welding and grinding spatters. The blankets are hemmed on all sides, without eyelets.

Article	Dimension	Temperature up to	Weight	Article no.
Standard blanket	W = 1000 mm, H = 1000 mm	550 °C* / 600 °C**	0,7 kg/pc.	THD-BAL-600-100x100
Standard blanket	W = 1000 mm, H = 2000 mm	550 °C* / 600 °C**	1,4 kg/pc.	THD-BAL-600-100x200
Standard blanket	W = 1000 mm, H = 3000 mm	550 °C* / 600 °C**	2,2 kg/pc.	THD-BAL-600-100x300
Standard blanket	W = 2000 mm, H = 2000 mm	550 °C* / 600 °C**	2,9 kg/pc.	THD-BAL-600-200x200
Standard blanket	W = 2000 mm, H = 3000 mm	550 °C* / 600 °C**	4,3 kg/pc.	THD-BAL-600-200x300
Customized blanket	made to size	550 °C* / 600 °C**	0,7 kg/m ²	THD-BAL-600-SG

THD-900 - Heat Protection Blankets made of finished glass fabrics, heat-resistant up to 750°C*/900°C**

The special finish of THD-900 has a high content of silica acide, which improves the protection against welding splashes, spatters and welding beads. The viscosity of the beads increases during contact with the material and will be fixed into the fabrics.

Article	Dimension	Temperature up to	Weight	Article no.
Standard blanket	W = 1000 mm, H = 1000 mm	750 °C* / 900 °C**	1,3 kg/pc.	THD-GRA-900-100x100
Standard blanket	W = 1000 mm, H = 2000 mm	750 °C* / 900 °C**	2,5 kg/pc.	THD-GRA-900-100x200
Standard blanket	W = 1000 mm, H = 3000 mm	750 °C* / 900 °C**	3,8 kg/pc.	THD-GRA-900-100x300
Standard blanket	W = 2000 mm, H = 2000 mm	750 °C* / 900 °C**	5,0 kg/pc.	THD-GRA-900-200x200
Standard blanket	W = 2000 mm, H = 3000 mm	750 °C* / 900 °C**	7,5 kg/pc.	THD-GRA-900-200x300
Customized blanket	made to size	750 °C* / 900 °C**	1,3 kg/m ²	THD-GRA-900-SG

THD-1100 - Heat Protection Blankets made of glass fabrics, heat-resistant up to 1000°C*/1100°C**

THD-1100 is a glass fabric made of silica-glass with a temperature resistance of more than 1000°C. The fabric is additionally finished with a special vermiculite formulation. This finish increases the abrasion and flame resistance and shows an improved cutting resistance. Weight: approx. 1.100 g/m², standard width: 920 mm. Color: golden-brown. Tried and tested against welding splashes, welding and grinding spatters.

Article	Size	Temperature up to	Weight	Article no.
Standard blanket	W = 920 mm, H = 1000 mm	1000 °C* / 1100 °C**	1,1 kg/pc.	THD-GOL-1100-92x100
Standard blanket	W = 920 mm, H = 2000 mm	1000 °C* / 1100 °C**	2,2 kg/pc.	THD-GOL-1100-92x200
Standard blanket	W = 920 mm, H = 3000 mm	1000 °C* / 1100 °C**	3,3 kg/pc.	THD-GOL-1100-92x300
Standard blanket	W = 1840 mm, H = 2000 mm	1000 °C* / 1100 °C**	4,4 kg/pc.	THD-GOL-1100-184x200
Standard blanket	W = 1840 mm, H = 3000 mm	1000 °C* / 1100 °C**	6,6 kg/pc.	THD-GOL-1100-184x300
Customized blanket	made to size	1000 °C* / 1100 °C**	1,1 kg/m ²	THD-GOL-1100-SG

* = permanent heat ** = peak temperature

Minimum price of a custom-made curtain is 50 €/Stück

Delivery ex stock

Delivery approx. 2-3 weeks

Heat Protection Curtains

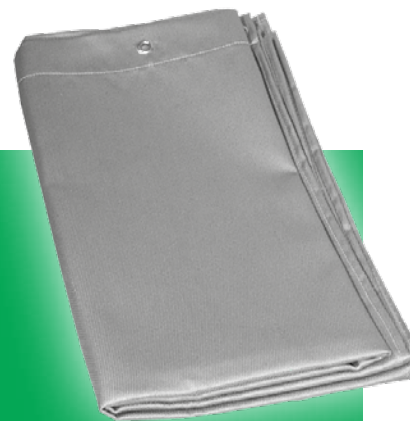

Heat protection curtains have a seam along the top and the bottom, brass eyelets along the top and selvedge on the sides. These curtains can be combined with film curtains (mixed curtains).

Maximum length THV 600 approx. 5000 mm
Maximum width THV 600 approx. 5000 mm
Maximum size 25 m²

Maximum length THV 1100 approx. 3000 mm
Maximum width THV 1100 approx. 5000 mm
Maximum size 15 m²

Heat protection curtains are made to customer's specification. Delivery time approx. 2–3 weeks.

Mixed curtains and special models

Heat protection curtains can be combined with TransTac welding protective curtains. Mixed curtains and special models are manufactured according to customer's specification. We will gladly pay attention to your requirements.

THV-600 - Heat Protection Curtains made of glass weave, heat-resistant up to 550°C*/600°C**

THV-600 is a glass fabric coated on both sides with grey polyurethane filled with aluminum and shows flame-resistant characteristics. Weight: approx. 720 g/m². Standard width: 1.000 mm. Color: gray silver.

Article	Temperature up to	Weight	Article no.
Standard curtain W = 1000 mm, H = 1800 mm	550 °C* / 600 °C**	1,3 kg/pc.	THV-BAL-600-100x180
Standard curtain W = 1000 mm, H = 2000 mm	550 °C* / 600 °C**	1,4 kg/pc.	THV-BAL-600-100x200
Standard curtain W = 2000 mm, H = 1800 mm	550 °C* / 600 °C**	2,6 kg/pc.	THV-BAL-600-200x180
Standard curtain W = 2000 mm, H = 2000 mm	550 °C* / 600 °C**	2,9 kg/pc.	THV-BAL-600-200x200
Custom made to size	550 °C* / 600 °C**	0,7 kg/m ²	THV-BAL-600-SG

THV-1100 - Heat Protection Curtains made of silica-glass, heat-resistant up to 1000°C*/1100°C**

THV-1100 is a glass fabric made of silica-glass with a temperature resistance of more than 1000°C. The fabric is additionally finished with a special vermiculite formulation. This finish increases the abrasion and flame resistance and shows an improved cutting resistance. Weight: approx. 1100 g/m², standard width: 920 mm. Color: golden brown.

Article	Temperature up to	Weight	Article no.
Standard curtain W = 920 mm, H = 1800 mm	1000 °C* / 1100 °C**	1,8 kg/pc.	THV-GOL-1100-92x180
Standard curtain W = 920 mm, H = 2000 mm	1000 °C* / 1100 °C**	2,0 kg/pc.	THV-GOL-1100-92x200
Standard curtain W = 1840 mm, H = 1800 mm	1000 °C* / 1100 °C**	3,6 kg/pc.	THV-GOL-1100-184x180
Standard curtain W = 1840 mm, H = 2000 mm	1000 °C* / 1100 °C**	4,0 kg/pc.	THV-GOL-1100-184x200
Custom made to size	1000 °C* / 1100 °C**	1,1 kg/m ²	THV-GOL-1100-SG

Cuttings/Accessories

Article	Article no.
Cutting with additional seam	–
Surcharge for additional brass eyelets, additional seam inclusive	–
Surcharge for additional metal snap fasteners, additional seam inclusive	–

Delivery ex stock

Delivery approx. 2-3 weeks

* = permanent heat ** = peak temperature
Minimum price of a custom-made curtain is 50,00 €/pc.

Heat Protection Pillows



THK-800 - Heat Protection Pillows made of carbon-glass needle felts, heat-resistant up to 550°C*/800°C**

The THK-800 carbon-glass needle felt is a new fabric made of a needled carbon fiber felt combined with a glass weave to increase the integrity and mechanical tensile strength. The fabric is absolutely not combustible and shows extremely less smoke during heating. The soft surface cares skin and avoids scratching on sensitive surfaces. The surface of the fabrics can selectively resist peak temperatures of more than 1000 °C (welding splashes and beads). The glass weave has a permanent temperature resistance of 550 °C in contact and a softening point of 840°C.

Article	Temperature up to	Weight	Article no.
Standard pillow W = 500 mm, L = 500 mm	550 °C* / 800 °C**	0,5 kg/pc.	THK-800-50x50
Standard pillow W = 500 mm, L = 1000 mm	550 °C* / 800 °C**	1,0 kg/pc.	THK-800-50x100
Standard pillow W = 500 mm, L = 2000 mm	550 °C* / 800 °C**	2,0 kg/pc.	THK-800-50x200
Pillow made to size	550 °C* / 800 °C**	–	THK-800-SG

THK-1100 - Heat Protection Pillows made of silica-glass, heat-resistant up to 1000°C*/1100°C**

THK-1100 is a glass fabric made of silica-glass with a temperature resistance of more than 1000°C. The fabric is additionally finished with a special vermiculite formulation. This finish increases the abrasion and flame resistance and shows an improved cutting resistance. Color: golden brown.

Article	Temperature up to	Weight	Article no.
Standard pillow W = 420 mm, L = 500 mm	1000 °C* / 1100 °C**	0,5 kg/pc.	THK-1100-42x50
Standard pillow W = 420 mm, L = 1000 mm	1000 °C* / 1100 °C**	0,9 kg/pc.	THK-1100-42x100
Standard pillow W = 420 mm, L = 2000 mm	1000 °C* / 1100 °C**	1,8 kg/pc.	THK-1100-42x200
Pillow made to size	1000 °C* / 1100 °C**	–	THK-1100-SG

Delivery ex stock

Delivery approx. 2-3 weeks

* = Permanent heat ** = peak temperature

DämmTac Protection Films

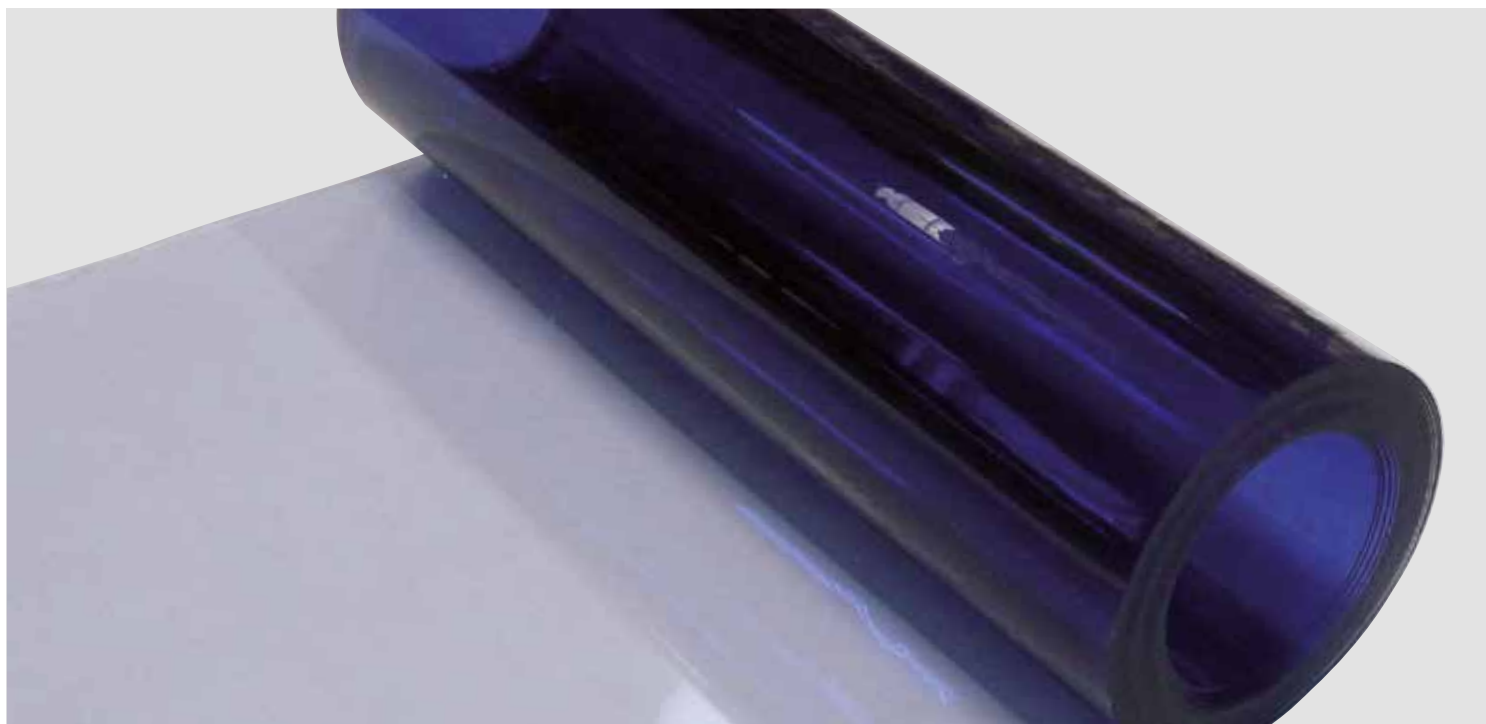

DämmTac / Material Rolls

DämmTac films are used as transparent partitions against draught, dust, moisture and noise. There are a wide range of thicknesses and sizes available to cover specific applications from dust protection partition and noise protection curtains to sheets for swing-doors.

Rolls, plastic, transparent

Rolls: 20 x 1,5 m / 20 x 1,0 m / 20 x 2,0 m

Thickness: 2, 3, 5, 7, mm

Size	Style	Colour	Packaging unit	Weight	Article no.
1,0 x 20 m x 2 mm	roll á 50 kg	clear	1 Roll (20 m ²)	2,50 kg/m ²	OCO-DT-SFG-2-10
1,0 x 20 m x 3 mm	roll á 75 kg	clear	1 Roll (20 m ²)	3,75 kg/m ²	OCO-DT-SFG-3-10
1,0 x 20 m x 5 mm	Roll á 125 kg	clear	1 Roll (20 m ²)	6,25 kg/m ²	OCO-DT-SFG-5-10
1,0 x 20 m x 7 mm	Roll á 175 kg	clear	1 Roll (20 m ²)	8,75 kg/m ²	OCO-DT-SFG-7-10
1,5 x 20 m x 2 mm	Roll á 75 kg	clear	1 Roll (30 m ²)	2,50 kg/m ²	OCO-DT-SFG-2
1,5 x 20 m x 3 mm	Roll á 112,5 kg	clear	1 Roll (30 m ²)	3,75 kg/m ²	OCO-DT-SFG-3
1,5 x 20 m x 5 mm	Roll á 187,5 kg	clear	1 Roll (30 m ²)	6,25 kg/m ²	OCO-DT-SFG-5
2,0 x 20 m x 2 mm	Roll á 100 kg	clear	1 Roll (40 m ²)	2,50 kg/m ²	OCO-DT-SFG-2-20
2,0 x 20 m x 3 mm	Roll á 150 kg	clear	1 Roll (40 m ²)	3,75 kg/m ²	OCO-DT-SFG-3-20

DämmTac Protection Films



DämmTac / Protection Films

DämmTac material cut to size is available in a thickness of 2, 3, 5, 7 and 10 mm. The maximum width is 2200 mm. Due to material properties of the film, a production within a millimeter is not possible. There may be tolerances in size up to 2%.







The cuttings are made to order. Therefore these items are not returnable.

Size	Style	Colour	Packaging unit	Weight	Article no.		
Thickness 2 mm	Cutting*	clear	–	2,50 kg/m ²	OCO-DT-ZUS-2		
Thickness 3 mm	Cutting*	clear	–	3,75 kg/m ²	OCO-DT-ZUS-3		
Thickness 5 mm	Cutting*	clear	–	6,25 kg/m ²	OCO-DT-ZUS-5		
Thickness 7 mm	Cutting*	clear	–	8,75 kg/m ²	OCO-DT-ZUS-7		
Thickness 10 mm	Cutting*	clear	–	12,5 kg/m ²	OCO-DT-ZUS-10		

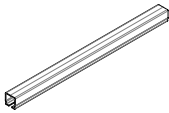
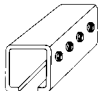
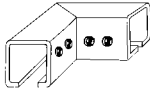
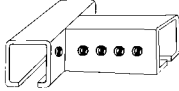
 Delivery approx. 2 weeks

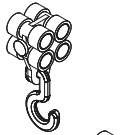

Special dimensions and cuttings as well as requirements more than 250 m² are available.
Please send us your inquiry! * Minimum price for cutting is 50,00 €/pc.

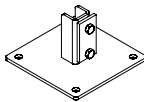
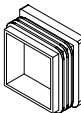
Curtain Accessories

Article	Description	Weight	Article no.	
	galvanized, 40 x 40 x 2,5 mm, length 6 m	2,5 kg/m	TTZ-C-PROFIL-6M	
	galvanized, 40 x 40 x 2,5 mm, length 2 m	2,5 kg/m	TTZ-C-PROFIL-2M	
	galvanized, 40 x 40 x 2,5 mm	2,5 kg/m	TTZ-C-PROFIL-40	
	Cutting according to customer's request, price/m			
Shipping with freight forwarding – additional charges for elongated items over 2,4 m				
	Rail connector	powder coated, for C-Rail 40 x 40 mm	650 g	TTV-Z-SCHI-VER
	L-connector	powder coated, for C-Rail 40 x 40 mm	1030 g	OCO-Z-VERB-W
	T-connector	powder coated, for C-Rail 40 x 40 mm	1370 g	OCO-Z-VERB-T
	90°-elbow	galvanized, C-Rail 40 x 40 mm, radius 400 mm	2500 g	TTV-Z-BOGEN-500
		galvanized, C-Rail 40 x 40 mm, radius 1000 mm	4000 g	TTV-Z-BOGEN-1000
	PA-hook	plastic, yellow, 7 hooks per curtain 1300 mm, for C-Rail 40 x 40 mm	7 g	TTV-Z-PA-HAKEN40
	Spring Clip	galvanized for 1" pipe	7 g	TTV-Z-K-HAKEN
	Plastic runner with hook	2 x 4 rolls, plastic, for C-Rail 40 x 40 mm	30 g	OCO-Z-LW-8-HAKEN
	Plastic runner without hook	2 x 4 rolls, plastic, for C-Rail 40 x 40 mm	26 g	OCO-Z-LW-8
	Endwall fixture	powder coated / galvanized for C-Rail 40 x 40 mm dowels and screws included	1.100 g	TTV-Z-WABE-STI
	End cap	plastic, black, for C-Rail 40 x 40 mm	10 g	TTV-Z-END-C



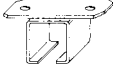
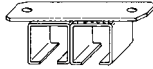
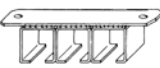
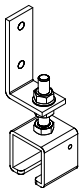
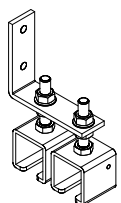
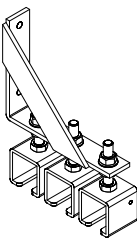
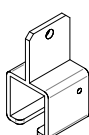

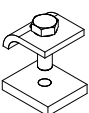
 Delivery ex stock

Curtain Accessories

Article	Description	Weight	Article no.
	Ceiling fixture powder coated, dowels and screws included for C-Rail 40 x 40 mm	440 g	TTV-Z-DEBE-STD
	Ceiling fixture double powder coated, dowels and screws included for C-Rail 40 x 40 mm	800 g	TTV-Z-DEBE-DOPP
	Ceiling fixture triple powder coated, dowels and screws included for C-Rail 40 x 40 mm	1850 g	TTV-Z-DEBE-DREI
	Wall fixture powder coated, gray for C-Rail 40 x 40 mm for end wall or side wall fixture nuts and washers included	600 g	TTV-Z-WABE-UNI
	Wall fixture double powder coated, gray for C-Rail 40 x 40 mm for side wall fixture nuts and washers included	1.100 g	TTV-Z-WABE-L-DOP
	Wall fixture triple powder coated, gray for C-Rail 40 x 40 mm or side wall fixture nuts and washers included	2.000 g	TTV-Z-WABE-L-DREI
	Rail holder with fixing clip powder coated, gray, for C-Rail 40 x 40 mm	350 g	TTV-Z-HALTER
	Buffer galvanized with rubber pad for C-Rail	120 g	OCO-Z-ENDANSCHLAG
	Clamp bolt galvanized, for C-Rail, range 4 -20 mm	160 g	OCO-Z-SPANNPRATZE

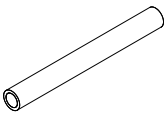
 Delivery ex stock

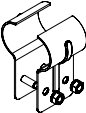
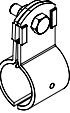
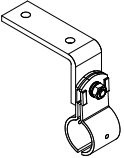
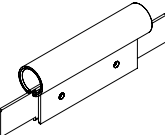
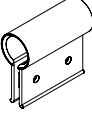
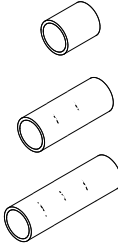
Strip Curtain Accessories

Article	Description	Weight	Article no.	
	Pipe	pipe 1", galvanized, length 6 m	2,3 kg/m	TTL-Z-ROHR-6M
		pipe 1", galvanized, length 2 m	2,3 kg/m	TTL-Z-ROHR-2M
		Cutting according to customer's request, price/m	2,3 kg/m	TTL-Z-ROHR
Shipping with freight forwarding – additional charges for elongated items over 2,4 m				
	End cap	plastic, black, for pipe 1"	3 g	TTL-Z-END-R
	Swing clamp	galvanized, for pipe 1", screws and nuts included for strips 2 – 3 mm	130 g	TTL-Z-S-SCHELLE-PIN
	Swing clamp	galvanized, for pipe 1", screws and nuts included for strips 5 mm	300 g	TTL-Z-S-SCHELLE5
	Pipe clamp	galvanized, for pipe 1", screws, washer and nuts included	160 g	TTL-Z-RL-SCHELLE TTL-Z-R-SCHELLE
	Wall and ceiling fixture	galvanized/powder coated, gray, for pipe 1", screws and dowels included	440 g	TTL-Z-WABE-R
	Rocket shell 200 mm	for pipe 1", plastic, blue, for strips with 33% overlap, screws included	210 g	TTL-Z-S-SCHELLE- BLAU-200
	Rocket shell 100 mm	for pipe 1", plastic, blue, for strips with 66%+100% overlap, screws included	120 g	TTL-Z-S-SCHELLE- BLAU-100
	Spacer	or pipe 1", plastic		
	50 mm	blue, to rocket shell	20 g	TTL-Z-DISTANZH-50
	170 mm	black, to swing clamp	60 g	TTL-Z-DISTANZH-170
	205 mm	black, to swing clamp	70 g	TTL-Z-DISTANZH-205
	Runner galvanized for C-Rail	bearing runner, 2 Rolls	0,16 kg	OCO-Z-LAUFROLLE

 Delivery ex stock

Strip Curtain Accessories

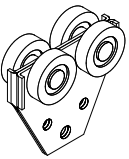
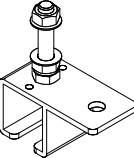
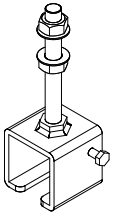
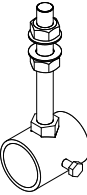
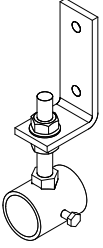
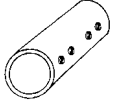
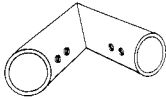
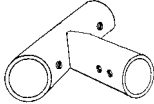
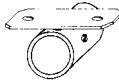
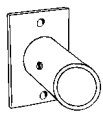
Article	Description	Weight	Article no.
	Runner galvanized, 2 rolls	0,31 kg	OCO-Z-LW-STAHL
	Double runner galvanized 2 x 2 rolls	0,41 kg	TTV-Z-UNI-LASCHE-C
	Universal C-Rail holder with thread, length 180 mm	0,45 kg	TTV-Z-UNIHALTER-180-C
	with thread, length 120 mm	0,40 kg	TTV-Z-UNIHALTER-100-C
	with thread, length 60 mm	0,36 kg	TTV-Z-UNIHALTER-C
	Universal pipe holder with thread, length 180 mm	0,45 kg	TTL-Z-ROHRBE-UNI-180
	with thread, length 100 mm	0,40 kg	TTL-Z-ROHRBE-UNI-100
	with thread, length 60 mm	0,25 kg	TTL-Z-ROHRBE-UNI
	End and side wall fixture or pipe 1", height adjustable, galvanized/powder coated, screws, nuts and dowels included	500 g	TTL-Z-ROHRBE-HÖH
	Pipe connector for pipe 1", powder coated, gray	400 g	TTL-Z-ROHR-VERB
	L-connector Powder coated, gray	660 g	TTL-Z-ROHRBE-WI
	T-connector powder coated, gray	660 g	TTL-Z-ROHRBE-T
	Ceiling fixture for pipe 1", powder coated, gray, screws, nuts and dowels included	380 g	TTL-Z-ROHRBE-DE
	End wall fixture for pipe 1", powder coated, gray, screws, nuts and dowel included	380 g	TTL-Z-ROHRBE-STI

Ceiling Suspensions







Ceiling suspension for C-Rail with powered curtains

Article	Description	Weight	Article no.	
	Ceiling suspension for C-Rail (with clamp bolt)	Clamp bolt, C-Rail, 6 m steel wire, turnbuckle and rail holder	3,00 kg	TTV-Z-DEAB-C-T
	Ceiling suspension for pipe 1" (with clamp bolt)	Clamp bolt, C-Rail, 6 m steel wire, turnbuckle and pipe holder	3,00 kg	TTL-Z-DEAB-R-T
	Ceiling suspension for C-Rail (with dowels)	Angle with dowels, C-Rail, 6 m steel wire, turnbuckle and rail holder	2,50 kg	TTV-Z-DEAB-C-D
	Ceiling suspension for pipe 1" (with dowels)	Angle with dowels, 6 m steel wire, turnbuckle and pipe holder	2,50 kg	TTL-Z-DEAB-R-D
	Ceiling suspension for C-Rail (rigid version)	Wall fixture with dowels, 2 m C-Rail, angle and universal rail holder	7,00 kg	TTV-Z-DEAB-C-ST
	Ceiling suspension for pipe 1" (rigid version)	Wall fixture with dowels, 2 m C-Rail, angle and universal pipe holder	7,00 kg	TTL-Z-DEAB-R-ST

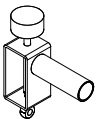
Delivery approx. 1 week

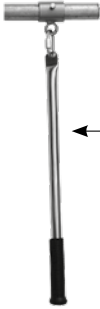
Universal Accessories

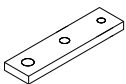
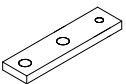
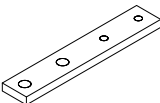
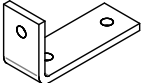
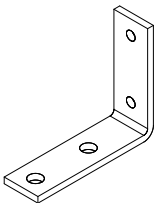
Article	Description	Weight	Article no.	
	Brake carriage with draw cable	galvanized, for pipe 1"	1000 g	TTL-Z-BREMSE
	Locking device	galvanized, for pipe 1"	150 g	TTL-Z-FESTST
	Tow bar	galvanized, for pipe 1", length 600 mm*	680 g	TTL-Z-ZUGST-600
	Tow bar	galvanized, for pipe 1", length 1000 mm*	800 g	TTL-Z-ZUGST-1000
	Tow bar	galvanized, for pipe 1", length 1500 mm*	950 g	TTL-Z-ZUGST-1500
	Square nut M8	25 x 30 x 6 mm, galvanized	30 g	OCO-Z-KLEMM-M8
	2 hole flat plate	70 x 35 x 6 mm, galvanized threaded hole: 2 x 9 mm	110 g	OCO-Z-HPLATTE-70
	3 hole flat plate	110 x 35 x 6 mm, galvanized threaded hole: 3 x 9 mm	150 g	OCO-Z-HPLATTE-110
	3 hole flat plate	140 x 40 x 10 mm, powder coated, black threaded hole: 2 x 9 mm + 1 x 13 mm	400 g	OCO-Z-HPLATTE-140
	4 hole flat plate	195 x 40 x 10 mm, powder coated, black threaded hole: 2 x 9 mm + 2 x 13 mm	550 g	OCO-Z-HPLATTE-195
	3 hole angle	100 x 55 x 35 x 6 mm powder coated, black threaded hole: 3 x 9 mm	0,25 kg	OCO-Z-W-100x55
		100 x 55 x 35 x 6 mm, powder coated, black threaded hole: 2 x 9 mm + 1 x 13 mm	0,25 kg	OCO-Z-W-100x55-G
	4 hole angle	100 x 120 x 35 x 6 mm powder coated, gray threaded hole: 2 x 9 mm + 2 x 13 mm	0,31 kg	OCO-Z-W-100x120-G
	Clamp bolt	6 x 10 mm		OCO-Z-SPANNSTIFT-6

Delivery approx. 1 week *with pipe holder

Stands



Top of the curtain support for C-Rail (stand 40 x 40 mm)

Top of the strip curtain support for pipe (stand 40 x 40 mm)

Top of the stand (stand 60 x 60 mm) Top plate 80 x 80 mm

Base of the stand (stand 60 x 60 mm) Base plate 250 x 250 mm

Stands for Curtains and Strip Curtains

Article	Description	Weight	Article no.
	Curtain support C-Rail-kit, 40 x 40 x 2,5 mm* H up to 2400 mm Stand cut to length, 2 flat plates and square nuts included	7,5 kg	TTV-Z-STÄNDER-23
	Strip Curtain Support C-Rail-Kit, 40 x 40 x 2,5 mm* H up to 2400 mm Stand cut to length, 2 pipe clamps included	7,5 kg	TTL-Z-STÄNDER-23
	Curtain stand 60 x 60 x 2,5 mm H 2000 - 2500 mm H 2500 - 3000 mm H 3000 - 3500 mm Reinforced base, adjustable in increments of 100 mm 2 square nuts included	14,0 kg 15,0 kg 16,0 kg	TTV-Z-STÄNDER-60-25 TTV-Z-STÄNDER-60-30 TTV-Z-STÄNDER-60-35
	Strip curtain stand 60 x 60 x 2,5 mm H 2000 - 2500 mm H 2500 - 3000 mm H 3000 - 3500 mm Reinforced base, adjustable in increments of 100 mm 2 pipe clamps included	14,0 kg 15,0 kg 16,0 kg	TTL-Z-STÄNDER-60-25 TTL-Z-STÄNDER-60-30 TTL-Z-STÄNDER-60-35
	Custom-made-stand 60 x 60 x 2,5 mm		TTZ-Z-STÄNDER-60-SONDER

Delivery ex stock

Delivery approx. 2-3 weeks

* = incl. dowels, screws and washes

Retracting Cable Reel



Retracting Cable Reel for Curtains

Suited for welding curtains with a maximum width of 8 m. The welding curtain is fixed on the straightened cable reel. For free entrance you push the curtain back to the firm part of the cable reel. Then put out the cable, the reel takes the cable automatically and you can pivot it.

Description

Weight

Article no.

For curtains

13 kg

TTS-SCHWENKSEILAUFR

Delivery approx. 2-3 weeks





First the curtain is pushed to the firm part of the cable reel. Then the clamp mechanism of the cable is loosened and the handle can be released. The steel cable automatically rolls back into the cable reel. The curtain holder can now be pivoted by 180° and then the path is clear in a few minutes.

Swivel Arms/Stands

In the manufacturing process of large parts, cross studs are very prejudicial to material handling. Swivel arms allow a total opening of welding cabins. Cranes and fork-lifts can go in and out without any obstacles. The swivel arms can be equipped with curtains or strips depending on the use.

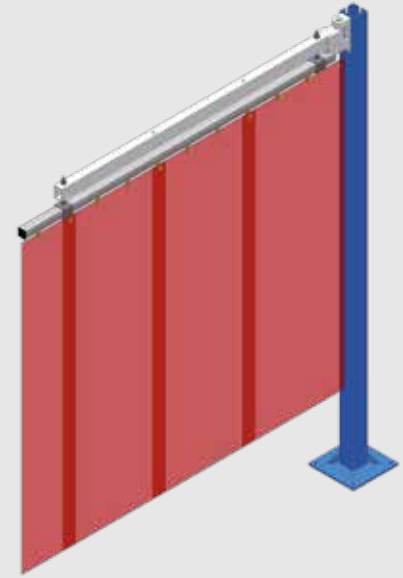
Of course, tools, balancers or welding machines can be fixed to the arm. 3 models with a load bearing capacity of 10 kg respectively 50 kg and a low construction are available. All swivel arms are manufactured to customer's specification.

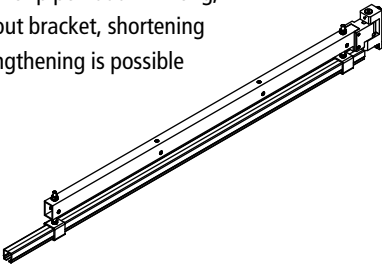
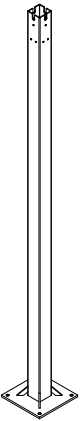

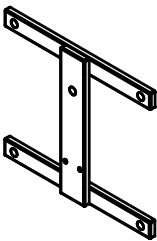
Article	Description	Weight kg/pc.	Article no.
<p>Swivel arm low, with stop C-Rail or pipe 2000 mm long, without bracket, shortening or lengthening is possible</p> 	Load bearing capacity 10 da. N line load		
	Swivel arm 1500, with C-Rail	18	TTS-MAM-1500-C
	Swivel arm 2000, with C-Rail	18	TTS-MAM-2000-C
	Swivel arm 3000, with C-Rail		TTS-MAM-3000-C
	Swivel arm 1500, with pipe	18	TTS-MAM-1500-R
	Swivel arm 2000, with pipe	18	TTS-MAM-2000-R
	Swivel arm 3000, with pipe		TTS-MAM-3000-R
	Swivel arm, special construction		TTS-MAM-2000-S
<p>Stand 80* Suited for swivel arm low 80 x 80 x 4 mm</p> 	H: 2.175 mm	29	TTS-SÄULE-80-M-200
	H: 2675 mm	34	TTS-SÄULE-80-M-250
	H: 3175 mm	39	TTS-SÄULE-80-M-300
	Special model		TTS-SÄULE-80-M-S
<p>Stand For swivel arm low 100 x 100 x 4 mm</p> 	H: 2.175 mm	29	TTS-SÄULE-100-M-200
	H: 2.675 mm	34	TTS-SÄULE-100-M-250
	H: 3.175 mm	39	TTS-SÄULE-100-M-300
	Special model		TTS-SÄULE-100-M-S
<p>Wall bracket* for swivel arm low</p> 	Flat steel, powder coated gray/ 1500	1,5	TTS-MAW-2
	For swivel arm/ 1500 – 2000		TTS-MAW-3
	For swivel arm/ 3000		TTS-MAW-5

Delivery time approx. 2-3 weeks

Shipping with freight forwarding – additional charges for elongated items over 2,4 m

Swivel Arms/Stand

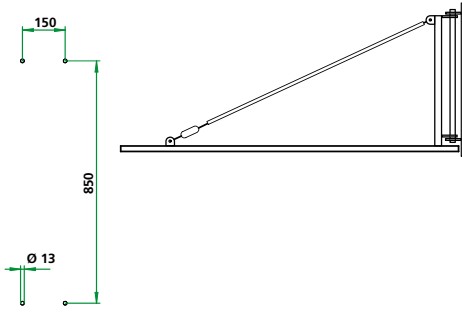
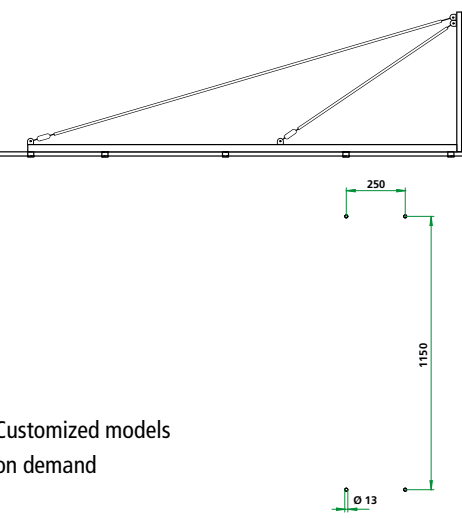

Article	Description	Weight kg/pc.	Article no.
Light wall-fixed swivel arms for curtains galvanized/powder coated Assembly with wall bracket or stand 	Pipe 1" Load bearing capacity 10 da. N line load L 2000 mm L 3200 mm	14 17	TTS-EK-10-2000-R TTS-EK-10-3200-R
	C-Rail 40 x 40 x 2,5 mm Load bearing capacity 10 da. N line load L 2000 mm L 3200 mm	14 17	TTS-EK-10-2000-C TTS-EK-10-3200-C
	Wall bracket		TTS-WK-10
Heavy-duty swivel arms for curtains galvanized/powder coated  Customized models on demand	Pipe 1" Load bearing capacity 50 da. N line load L 2000 mm L 3000 mm L 4000 mm, reinforced construction L 5000 mm, reinforced construction L 6000 mm, reinforced construction	16 23 41 51 61	TTS-EK-50-2000-R TTS-EK-50-3000-R TTS-EK-50-4000-R TTS-EK-50-5000-R TTS-EK-50-6000-R
	C-Rail 40 x 40 x 2,5 mm Load bearing capacity 50 da. N line load L 2000 mm L 3000 mm L 4000 mm, reinforced construction L 5000 mm, reinforced construction L 6000 mm, reinforced construction	16 23 41 51 61	TTS-EK-50-2000-C TTS-EK-50-3000-C TTS-EK-50-4000-C TTS-EK-50-5000-C TTS-EK-50-6000-C
	Wall bracket		TTS-WK-50

Delivery approx. 2-3 weeks

Shipping with freight forwarding – additional charges for elongated items over 2,4 m

Swivel Arms/Stands



Swivel Arms/Stands

Universal stand for swivel arms, exhausting arms, cable reels (painted black) and reinforced rails for strip curtains

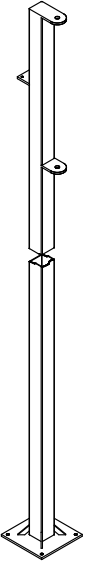
Article	Description	Weight kg/pc.	Article no.
Universal stand 	For light swivel arms up to 3200 mm extension 80 x 80 x 4 mm H up to 3000 mm H up to 4500 mm	32 46	TTS-SÄULE-80-30 TTS-SÄULE-80-45
	For medium-heavy swivel arms up to 4000 mm Ausladung 100 x 100 x 4 mm H up to 3000 mm H up to 4500 mm	48 69	TTS-SÄULE-100-30 TTS-SÄULE-100-45
	Für schwere Schwenkarme bis 6000 mm Ausladung 120 x 120 x 4 mm H up to 3000 mm H up to 4500 mm	48 69	TTS-SÄULE-120-30 TTS-SÄULE-120-45
	60 x 60 x 3 mm up to 4000 mm		TTS-AUSST-60
	80 x 80 x 4 mm up to 6000 mm		TTS-AUSST-80
	100 x 100 x 4 mm up to 6000 mm		TTS-AUSST-100
120 x 120 x 4 mm up to 8000 mm		TTS-AUSST-120	

Delivery approx. 3 Wochen

Shipping with freight forwarding – additional charges for elongated items over 2,4 m

Swivel Arms



Swivel Arms

Swivel arms for curtains

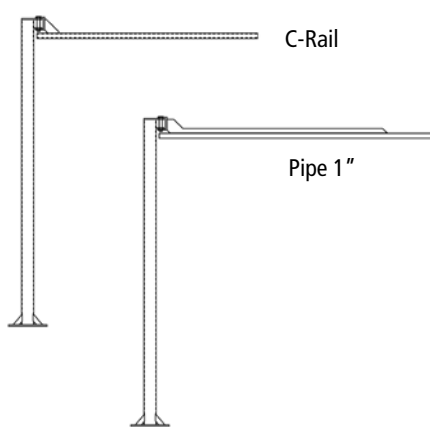
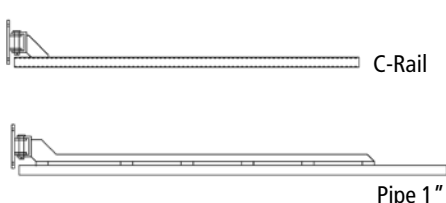
Article	Description	Article no.
Light swivel arm stand 	C-Rail 40x40x2,5 mm, Length 1200 mm Pipe 1", Length 1200 mm Height: 2000 mm Stand: 60 x 60 x 2,5 mm	TTS-S-MINI-1200-C TTS-S-MINI-1200-R
	C-Rail 40x40x2,5 mm, Length 1800 mm Pipe 1", Length 1800 mm Height: 2000 mm Stand: 80 x 80 x 2,5 mm	TTS-S-MINI-1800-C TTS-S-MINI-1800-R
Light wall-fixed swivel arm 	C-Rail 40x40x2,5 mm, Length 1200 mm Pipe 1", Length 1200 mm C-Rail 40x40x2,5 mm, Length 1800 mm Pipe 1", Length 1800 mm	TTS-W-MINI-1200-C TTS-W-MINI-1200-R TTS-W-MINI-1800-C TTS-W-MINI-1200-R
	Mini wall-fixed swivel arm	Special construction

Delivery time approx. 3 weeks

Telescopic Rails



Strip curtains and a combination of telescopic rail with swivel arms and heavy-duty stands

Telescopic Rails

If cranes operate in production shops, it is not always possible to lift the workpiece over the cross member that is supporting the welding curtains or strips. If the available space is very limited, then telescopic rails can be used to construct a welding partition that does not hinder the transport of materials by crane. TransTac curtains are the ideal product to use with the telescopic rails due to their low weight, however 2 mm strips can also be utilized up to an appropriate height. It is possible to combine the telescopic rail with a swivel arm, this saves space within the rotational range of the arm and is often used in situations where there are narrow spaces and cranes in operation.

Single telescopic rails

Guide rail 500 mm
Extension 1000 mm

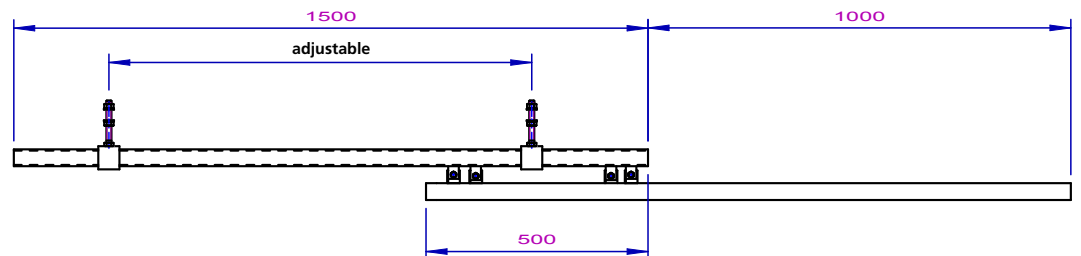

Article

Description

Weight kg/pc.

Article no.

	Extension with C-Rail	Extension 1000 mm With C-Rail 40 x 40 mm	9 kg	TTZ-TELESKOP-1000-C		
	Extension with pipe	Extension 1000 mm With pipe 1"	9 kg	TTZ-TELESKOP-1000-R		
	with accompanying C-Rail	Extension 1000 mm With accompanying C-Rail	14 kg	TTZ-TELESKOP-SAT-1000-C		
	with accompanying pipe	Extension 1000 mm With accompanying pipe	14 kg	TTZ-TELESKOP-SAT-1000-R		

Telescopic Rails

Reinforced single telescopic rails

Guide rail 700 mm

Extension 2000 mm

Reinforced C-Rail

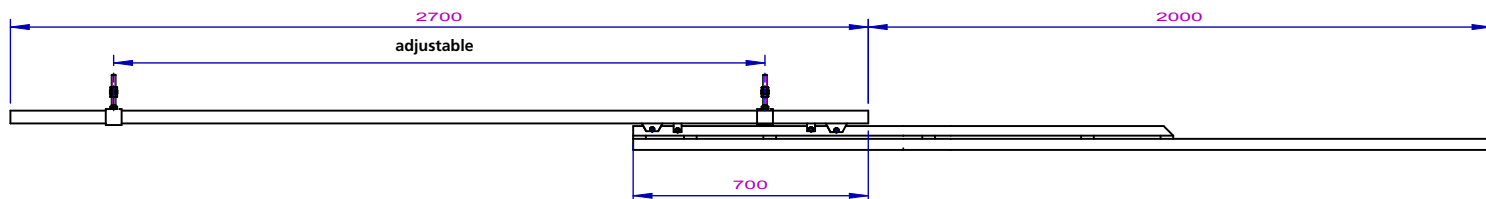

	Description	Weight	Article no.		
	Extension with C-Rail	Extension 2000 mm With C-Rail 40 x 40 mm	19 kg	TTZ-TELESKOP-2000-C	
	Extension with pipe	Extension 2000 mm, With pipe 1"	19 kg	TTZ-TELESKOP-2000-R	
	With accompanying C-Rail	Extension 2000 mm, with accompanying C-Rail 40 x 40 mm	26 kg	TTZ-TELESKOP-SAT-2000-C	
	With accompanying pipe	Extension 2000 mm With accompanying pipe 1"	26 kg	TTZ-TELESKOP-SAT-2000-R	

Shipping with freight forwarding – additional charges for elongated items over 2,4 m

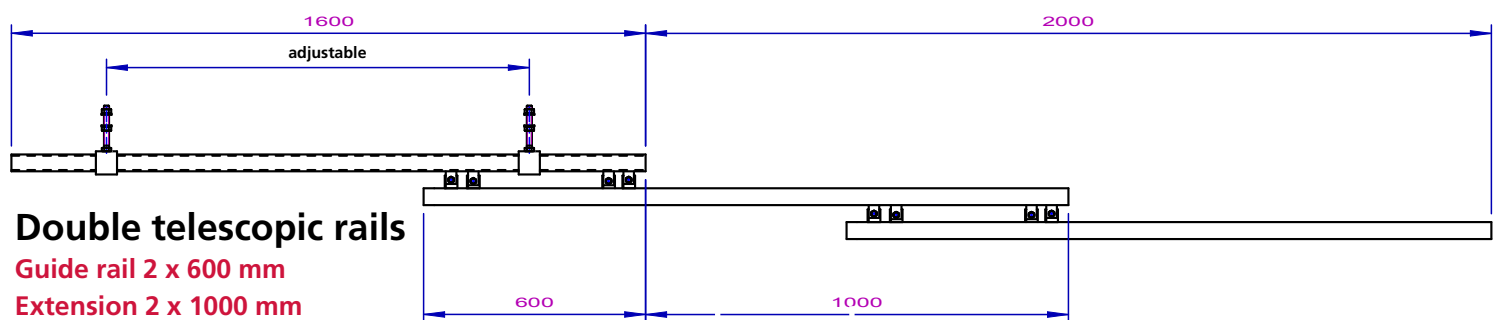

Double telescopic rails

Guide rail 2 x 600 mm

Extension 2 x 1000 mm

Article	Description	Weight	Article no.		
	Extension with C-Rail	L 2000 mm, C-Rail 40 x 40 mm	15 kg	TTZ-TELESKOP-DOP-2000-C	
	Extension with pipe	L 2000 mm, Pipe	15 kg	TTZ-TELESKOP-DOP-2000-R	
	With accompanying C-Rail	L 2000 mm, C-Rail 40 x 40 mm	25 kg	TTZ-TELESKOP-SAT-DOP-2000-C	
	With accompanying pipe	L 2000 mm, Pipe	25 kg	TTZ-TELESKOP-SAT-DOP-2000-R	

Delivery approx. 2- 3 weeks

TransMatic

TransMatic Powered Curtains

The new TransTac powered curtains can easily be opened by touching the buttons – or a fully automatic version is available. There are no disruptive elements such as columns, girders or anchorages since the system is fixed to ceiling. Enabling curtains to be whisked away for unparalleled ease of access, ideal for areas where fork trucks or cranes operate.

The advantages of this system are:

- Flexible separation of workplaces, machines or industrial robots
- Combination of welding curtains and protective clear curtains (T0) can be manufactured
- High headroom is achievable
- Motor limits (up and down) can be set directly at the motor



Article

Drive shaft with bearing, motor and mounting (price for curtain 2000 mm)	TTX-ROLLO-ELEK-S		
Curtain ready for fixing to the drive shaft Price for curtain: W = 2000 mm x H = 2500 mm, thickness 1 mm, T40 (red orange)	TTL-T40-1MM-SG		
Switch for tubular drive (up/down) – (optional)	TTX-Z-ROLLO-SCHALTER		
Control box GS3/4 for the control of up to 4 drives. Maximum 4 control boxes can be connected and operated by one switch – (optional)	on demand		
Audio remote control – (optional)	on demand		
Tubular drive 20 Nm 220V / 50 Hz (Spare set)	TTX-Z-ROLLO-MOTOR-70		

Article no.

TransMatic Powered Curtains / Sliding Rail

All TransTac curtain materials can be used (including protective curtains, strip curtains and strips). The system is created to provide customized solutions and we will be delighted to assist you with your specific requirements.

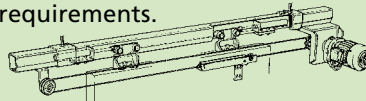

The advantaged of this system are:

- Automatic opening and closing of doors and gates
- Operational controls available vary from manual (touch of a button) to fully automatic systems
- Powerful motor – with limiter of lateral distance traveled
- Can be combined with all TransTac curtains, strip curtains and strips



Article

Sliding door motor 220 V / 50 Hz. 40 W, approx. 0,18 sec	TTX-Z-SCHI-ANTRIEB-1		
Control for the sliding door motor	TTX-Z-SCHI-STEUERUNG		
Push button, triple	TTX-Z-SCHI-DRUCKTASTER		
Drive belt for sliding door motor	TTX-Z-SCHI-ZAHNRIEMEN		
Driver for drive belt (double wing door)	TTX-Z-SCHI-MITN-Z		
Sliding System with infrared beam sensor and safety beam	on demand		

Article no.

■ Delivery approx. 2 – 3 weeks

Planning a Project



Example: Welding cabin for larger pieces

From the first contact
up to the realization

GENERAL PROCEDURE:

- Creating an offer on the basis of the provided sketch

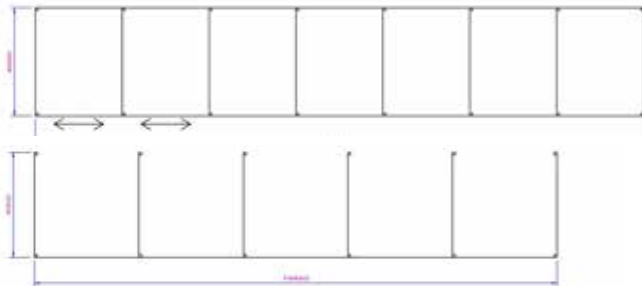

- Placing of order
- Manufacture of the strips / Commissioning of the components
- Delivery to the customer
- Assembly of the delivered components / Mounting the strips



BEISPIEL EINES FERTIGEN PROJEKTES

Our customer placed an order for the company to build five welding cabins for large parts. The main focus was to make sure that the cabins could be opened wide enough for the cranes and forklifts to pass through with the load. The parts only need to be changed every two to three days and therefore it had been decided that swivel arms would be the best option. Each of the front walls could be opened with a swivel arm.

It was important that the people could enter even while the swivel arms were closed. Thus we had decided to use strip curtains which could easily be moved to the side.

THE DELIVERY INCLUDES:

- 36 welding cabins 3,25 x 3,90 m
- Back and front strips are in T75 (dark green mat) to avoid any irritations
- Strengthened support structure
- Front strips in T40 (red orange) have a triple fixing system)



SINOtec®

SINOtec
SicherheitsSysteme GmbH
Senefelderstraße 17
D-63322 Rödermark
Telefon: +49 (0) 60 74 / 85 22-0
Telefax: +49 (0) 60 74 / 85 22-26
E-Mail: info@sinotec.de



Special brochures:

SINOtec has many different product ranges, therefore we have detailed delivery programs, brochures and leaflets. Technical information sheets and certificates are also available.



Please download at:

www.sinotec.de

or request at:

info@sinotec.de

The product ranges "TransTac B1" and "Mobile Protective Partitions" can be found in separate delivery programs.

Our terms of delivery and payment can be found in "SINOtec Products 2018" or as a download.

SINOtec - Partner

*TransTac product range. Date of issue: Aug. 2018 – Subject to alterations.
Copies – even extracts – need to be licensed by SINOtec.*

www.sinotec.de